

4K@60/HDCP 2.2 HDBaseT Extender

HDC-TH100-D/HDC-RH100-D

<User Guide>

Ver.1.8.0

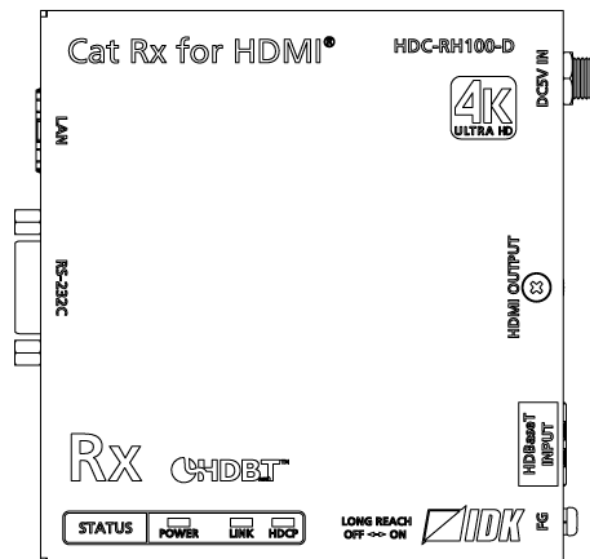
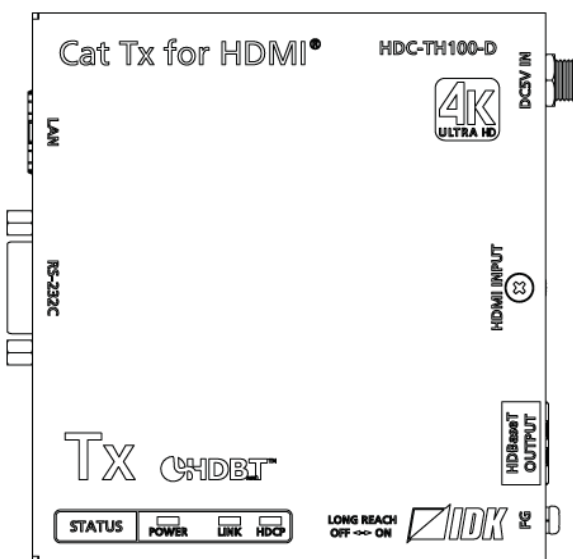

- Thank you for choosing our product.
- To ensure the best performance of this product, please read this user guide fully and carefully before using it and keep this manual together with the product for future reference as needed.

Trademarks

- HDBaseT™ and the HDBaseT Alliance Logo are trademarks of the HDBaseT Alliance.
- The terms HDMI and HDMI High-Definition Multimedia Interface, and the HDMI Logo are trademarks or registered trademarks of HDMI Licensing Administrator, Inc. in the United States and other countries.
- SDVoE™ and SDVoE logo are trademarks of SDVoE Alliance.
- All other company and product names mentioned in this document are either registered trademarks or trademarks of their respective owners. In this document, the “®” or “™” marks may not be specified.
- ©2018 IDK Corporation, all rights reserved.

Before reading this manual

- All rights reserved.
- Some information contained in this User guide such as exact product appearance, diagrams, menu operations, and so on may differ depending on the product version.
- This User guide is subject to change without notice. You can download the latest version from IDK's website at: www.idkav.com

FCC STATEMENT

Note: This equipment has been tested and found to comply with the limits for a Class A digital device, pursuant to part 15 of the FCC Rules. These limits are designed to provide reasonable protection against harmful interference when the equipment is operated in a commercial environment. This equipment generates, uses, and can radiate radio frequency energy and, if not installed and used in accordance with the instruction manual, may cause harmful interference to radio communications. Operation of this equipment in a residential area is likely to cause harmful interference, in which case the user will be required to correct the interference at his own expense.

(Class A)

**Supplier's Declaration of Conformity
47 CFR § 2.1077 Compliance Information**

Unique Identifier

Type of Equipment: Cat Tx for HDMI®, Cat Rx for HDMI®
Model Name: HDC-TH100-D, HDC-RH100-D

Responsible Party – U.S. Contact Information

Company Name: IDK America Inc.
Address: 72 Grays Bridge Road Suite 1-C, Brookfield, CT 06804
Telephone number: +1-203-204-2445
URL: www.idkav.com

FCC Compliance Statement

This device complies with Part 15 of the FCC Rules. Operation is subject to the following two conditions: (1) This device may not cause harmful interference, and (2) this device must accept any interference received, including interference that may cause undesired operation.

(FCC SDoC)

CE MARKING

This equipment complies with the essential requirements of the relevant European health, safety and environmental protection legislation.

WEEE MARKING





Waste Electrical and Electronic Equipment (WEEE), Directive 2002/96/EC
(This directive is only valid in the EU.)







This equipment complies with the WEEE Directive (2002/96/EC) marking requirement.
The left marking indicates that you must not discard this electrical/electronic equipment in domestic household waste.

Safety Instructions

Read all safety and operating instructions before using this product. Follow instructions and heed warnings/cautions.

Instructions and warnings/cautions for all products are provided. Some of them may not be applicable to your product.

	<h2>Warning</h2>	Indicates the presence of a hazard that may result in death or serious personal injury if the warning is ignored or the product is handled incorrectly.
	<h2>Caution</h2>	Indicates the presence of a hazard that may cause minor personal injury or property damage if the caution is ignored or the product is handled incorrectly.

Symbol	Description	Example
 Caution	This symbol is intended to alert the user. (Warning and caution)	 Hot surfaces Caution
 Prohibited	This symbol is intended to prohibit the user from specified actions.	 Do not disassemble
 Instruction	This symbol is intended to instruct the user.	 Unplug

Warning

For lifting heavy products:

 Instruction	<ul style="list-style-type: none"> ● Lifting must be done by two or more personnel. <p>To avoid injury: When lifting the product, bend your knees, keep your back straight and get close to it with two or more persons.</p>
--	--





For installing and connecting products:

 Prohibited	<ul style="list-style-type: none"> ● Do not place the product in unstable place. <p>Install the product in a horizontal and stable place, as this may fall or tip over and cause injury.</p> <ul style="list-style-type: none"> ● Secure the product if installing in the locations with vibration. <p>Vibration may move or tip over the product unexpectedly, resulting in injury.</p>
---	--

Warning

 Instruction	<ul style="list-style-type: none"> ● Installation work must be performed by professionals. The product is intended to be installed by skilled technicians. For installation, please contact a system integrator or IDK. Improper installation may lead to the risk of fire, electric shock, injury, or property damage. ● Insert the power plug into an outlet that is unobstructed. Unobstructed access to the plug enables unplugging the product in case of any extraordinary failure, abnormal situation or for easy disconnection during extended periods of non-use. ● Insert the power plug into an appropriate outlet completely. If the plug is partially inserted, arcing may cause the connection to overheat, increasing the risk of electric shock or fire. Do not use a damaged plug or connect to a loose outlet. ● Unplug the product from an AC power source during installation or service. When connecting peripheral devices to this product, unplug all involved devices from outlets. Ground potential differences may cause fire or other difficulties. ● The product must be electrically earthed/grounded. To reduce the risk of electric shock, ensure the product is connected to a mains socket outlet with a protective earthing connection. ● For PoE/PoH, use category cables meeting IEEE802.3af/at. Otherwise, it may cause problems or a fire.
---	--

For operating products:

 Prohibited	<ul style="list-style-type: none"> ● Keep out any foreign objects. To avoid fire or electric shock, do not permit foreign objects, such as metal and paper, to enter the product from vent holes or other apertures. ● For power cable/plug and Category cable, <ul style="list-style-type: none"> • Do not scratch, heat, or modify, including splicing or lengthening them. • Do not pull, place heavy objects on them, or pinch them. • Do not bend, twist, tie or clamp them together forcefully. <p>Misuse of the power cable and plug may cause fire or electric shock. If power cables/plugs become damaged, contact your IDK representative.</p>
 Do not disassemble	<ul style="list-style-type: none"> ● Do not repair, modify or disassemble. Since the product includes circuitry that uses potentially lethal, high voltage levels, disassembly by unauthorized personnel may lead to the risk of fire or electric shock. For internal inspection or repair, contact your IDK representative.
 Do not touch	<ul style="list-style-type: none"> ● Do not touch the product and connected cables during electric storms. Contact may cause electric shock.
 Instruction	<ul style="list-style-type: none"> ● Clean the power plug regularly. If the plug is covered in dust, it may increase the risk of fire.



If the following problem occurs:

 Unplug	<ul style="list-style-type: none"> ● Unplug immediately if the product smokes, makes unusual noise, or produces a burning odor. ● Unplug immediately if the product is damaged by falling or having been dropped. ● Unplug immediately if water or other objects are directed inside. <p>If you continue to use the product under these conditions, it may increase the risk of electric shock or fire. For maintenance and repair, contact your IDK representative.</p>
--	--



Caution

For installing and connecting products:

 <p>Prohibited</p>	<ul style="list-style-type: none"> ● Do not place the product in a location where it will be subjected to high temperatures. If the product is subjected to direct sunlight or high temperatures while under operation, it may affect the product's performance and reliability and may increase the risk of fire. ● Do not store or operate the product in dusty, oil smoke filled, or humid place. Placing the product in such environment may increase the risk of fire or electric shock. ● Do not block the vent holes. If ventilation slots are blocked, it may cause the product to overheat, affecting performance and reliability and may increase the risk of fire. ● Do not place or stack heavy items on the product. Failure to observe this precaution may result in damage to the product itself as well as other property and may lead to the risk of personal injury. ● Do not exceed ratings of outlet and wiring devices. Exceeding the rating of an outlet may increase the risk of fire and electric shock.
 <p>No wet hands</p>	<ul style="list-style-type: none"> ● Do not handle power plug with wet hands. Failure to observe this precaution may increase the risk of electric shock.
 <p>Instruction</p>	<ul style="list-style-type: none"> ● Use and store the product within the specified temperature/humidity range. If the product is used outside the specified range of temperature and humidity continuously, it may increase the risk of fire or electric shock. ● Do not place the product at elevations of 1.24 mi. (2,000 m) or higher above sea level. Failure to do so may shorten the life of the internal parts and result in malfunctions. ● When mounting the product into the rack, provide sufficient cooling space. Mount the product in a rack meeting EIA standards, and maintain spaces above and below for air circulation. For your safety as required, attach an L-shaped bracket in addition to the panel mount bracket kit to improve mechanical stability. ● Never insert screws without the rubber feet into the threaded holes on the bottom of the product. Never insert screws alone into the threaded holes on the bottom of the product. Doing so may lead to damage when the screws contact electric circuitry or components inside the product. Reinstall the originally supplied rubber feet using the originally supplied screws only.

For operating products:





 <p>Hot surfaces Caution</p>	<p>For products with the hot surfaces caution label only:</p> <ul style="list-style-type: none"> ● Do not touch the product's hot surface. <p>If the product is installed without enough space, it may cause malfunction of other products. If you touch product's hot surface, it may cause burns.</p>
 <p>Prohibited</p>	<ul style="list-style-type: none"> ● Use only the supplied power cable and AC adapter. ● Do not use the supplied power cable and AC adapter with other products. <p>If non-compliant adapter or power cables are used, it may increase the risk of fire or electric shock.</p>
 <p>Unplug</p>	<ul style="list-style-type: none"> ● If the product won't be used for an extended period of time, unplug it. <p>Failure to observe this precaution may increase the risk of fire.</p> <ul style="list-style-type: none"> ● Unplug the product before cleaning. <p>To prevent electric shock.</p>
 <p>Instruction</p>	<ul style="list-style-type: none"> ● Do not prevent heat release. <p>If cooling fan stops, power off the product and contact IDK. Failure to do so may raise internal temperature and increase the risk of malfunction, fire, or electric shock.</p> <ul style="list-style-type: none"> ● Keep vents clear of dust. <p>If the vent holes near the cooling fan or near the fan are covered with dust, internal temperatures increase and may increase the risk of malfunction. Clean the vent holes and near the fan as needed. If dust accumulates inside of the product, it may increase the risk of fire or electric shock. Periodic internal cleaning, especially before humid rainy season, is recommended. For internal cleaning, contact your IDK representative.</p>

Table of Contents

1	Included Items	10
2	Product outline	11
3	Features	12
4	System Configuration Example.....	13
5	Panels	14
5.1	Transmitter (HDC-TH100-D).....	14
5.2	Receiver (HDC-RH100-D)	16
6	Precautions	18
6.1	Installation.....	18
6.1.1	Installing on wall or ceiling	18
6.2	Cabling.....	19
6.2.1	Cables	20
6.2.2	Category cable for extension	21
6.2.3	LAN cable.....	22
6.2.4	RS-232C cable.....	22
6.2.5	RS-232C communication function.....	22
6.2.6	Cascade connection.....	22
6.2.7	DVI signals with copyright protection	23
6.2.8	AC adapter with screw locking mechanism	24
7	Specifications.....	25
7.1	RS-232C pin assignment.....	25
7.2	Product specification.....	27
8	Troubleshooting	28

1 Included Items

Ensure all items below are included in the package.

If any items are missing or damaged, please contact IDK.

■ Transmitter

- HDC-TH100-D (main unit) x1
- AC adapter x1

■ Receiver

- HDC-RH100-D (main unit) x1
- AC adapter x1

This User Guide is common to both the transmitter and receiver. You can download the latest version from IDK's website at: www.idkav.com

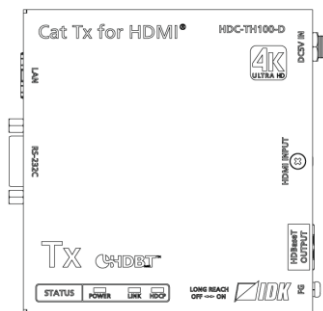

HDC-TH100-D (Transmitter)



HDC-RH100-D (Receiver)

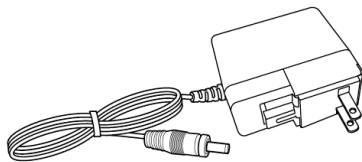

AC adapter

[Fig. 1.1] Included items

2 Product outline

The HDC-TH100-D/HDC-RH100-D (hereafter referred to as “HDC”) are extender for a long-haul transmission of HDMI signal over one single category cable.

The image quality will not be deteriorated, since video signal is transmitted at a resolution up to 4K@60 without compression.

You can also control external devices that are connected to the HDC over RS-232C and LAN by registering external control commands.

Input video signal is converted to HDBaseT signal and sent up to 328 ft. (100 m).

For Long reach mode, use IDK's HDBaseT product supporting up to 328 ft. (100 m).

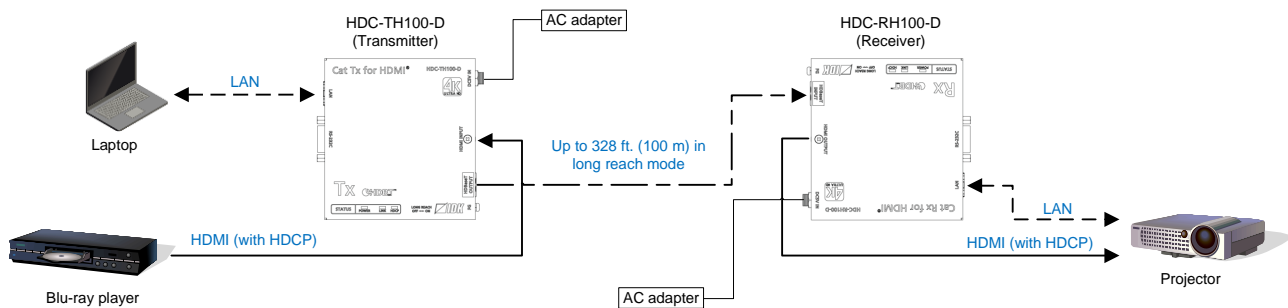

[Fig. 2.1] Application example (HDC-TH100-D and HDC-RH100-D are connected)

3 Features

■ Video

- Up to 4K@60 (4:2:0)
- HDCP 1.4/2.2 (Pass-through)
- Up to 328 ft. (100 m) 4K@60 over CAT.5E HDC/Cat5e STP/Cat6 STP cable
- Transmission over Cat5e UTP cable*¹
- Up to 328 ft. (100 m) over Cat6 UTP cable*²
- Up to 492 ft. (150 m) in Long reach mode (1080p 60 Hz 24 bit or less)*³
- No actual extension delay (10 μ s or less/328 ft. (100 m))

■ Others

- CEC (Pass-through)
- AC adapter with locking mechanism
- Up to 4 units can be installed in a 1U rack

*1 For transmission distance longer than 164 ft. (50 m), CAT.5E HDC, Cat5e STP or Cat6 UTP/STP cables are recommended.

*2 For 4K format longer than 230 ft. (70 m), CAT.5E HDC/Cat5e STP or Cat6 STP cables are recommended.

*3 For Long reach mode 328 ft. (100 m) or longer (up to 492 ft. (150 m)), CAT.5E HDC/Cat5e STP or Cat6 STP cables are recommended. Use HDC-TH100-D/HDC-RH100-D/IDK's HDBaseT products that support 328 ft. (100 m) .

4 System Configuration Example

Example: MSD-802UHD, source and sink devices are connected to the HDC.

The MSD-802UHD supplies power (PoH) from the HDBaseT input connector. However, since the HDC does not support PoH receiving function, the provided AC adapter is required to power the HDC.

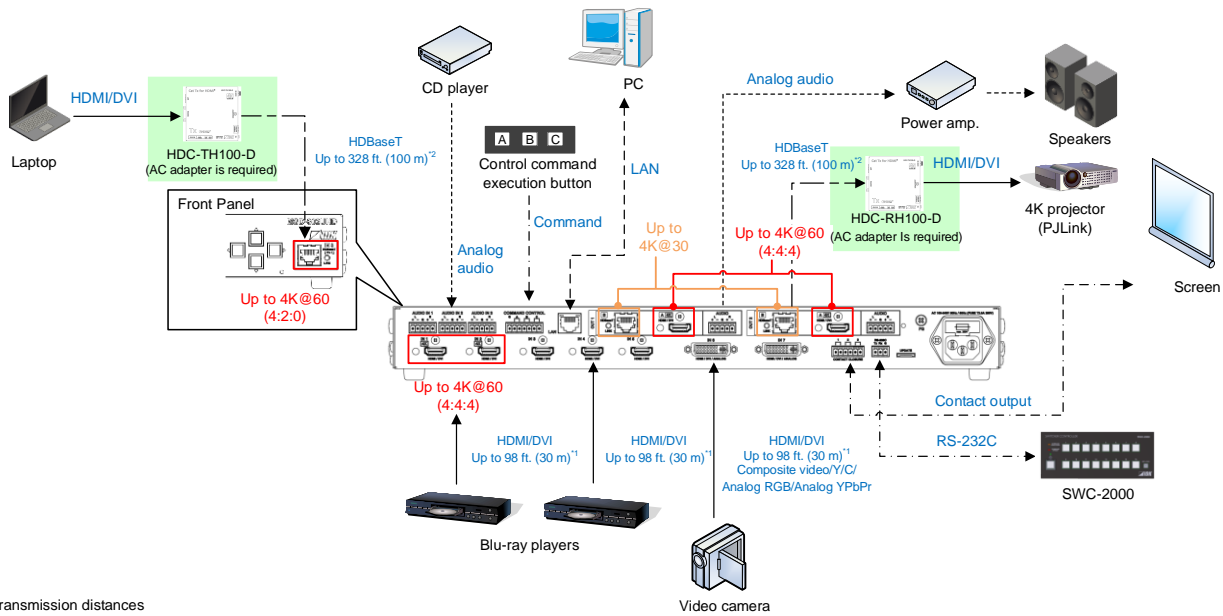

¹Transmission distances

Up to 98 ft. (30 m): 1080p@60

Up to 39 ft. (12 m): 4K@60 (when 18 Gbps high-speed cable is used) (IN1, IN2, OUT1 and OUT2 only)

²Transmission distances

Up to 328 ft. (100 m): Input/4K@60 (4:2:0), Output/4K@30

Up to 492 ft. (150 m): 1080p (24 bit) in Long reach mode. For Long reach mode, use IDK's category cable products that supports 328 ft. (100 m) or longer.

[Fig. 4.1] Application example

5 Panels

5.1 Transmitter (HDC-TH100-D)

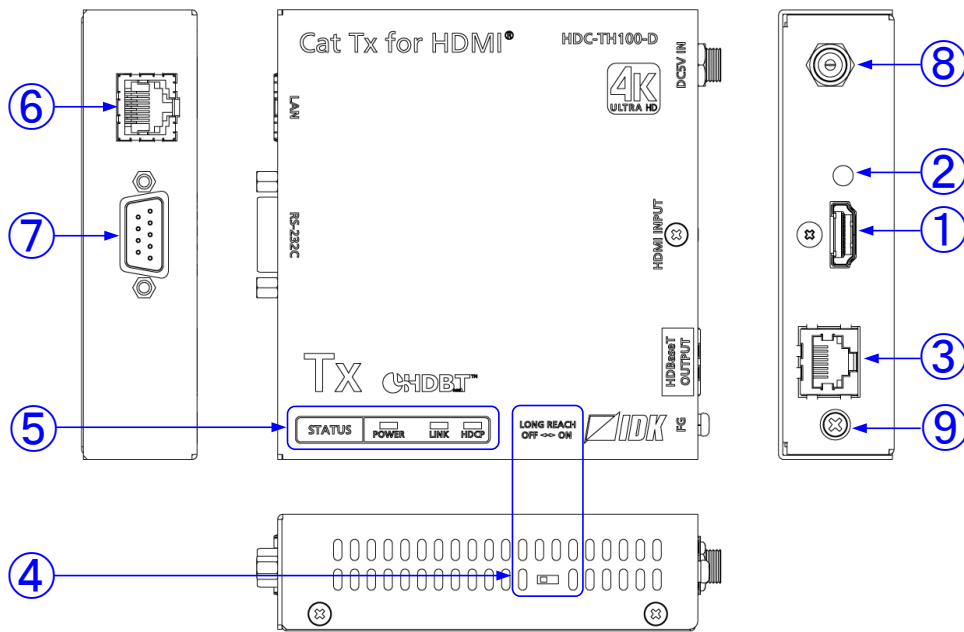

[Fig. 5.1] Transmitter drawing

[Table 5.1] Transmitter features

[1/2]

#	Feature	Description
①	HDMI input connector	Input connector for HDMI and DVI signals to interface source devices, such as Blu-ray players
②	HDMI cable fixing hole (Not used)	Not used.
③	HDBaseT output connector	Output connector for HDBaseT signal Connects to HDC-RH100-D or HDBaseT product
④	Long reach mode setting switch	Enables/disables long reach mode of HDBaseT output for up to 1080p (24 bit) or dot clock 148 MHz ON : Enables long reach mode* (Up to 492 ft. (150 m)) OFF: Disables long reach mode (Up to 328 ft. (100 m)) *For long reach mode, use HDC-RH100-D or IDK's HDBaseT product supporting up to 328 ft. (100 m)

#	Feature	Description
⑤	LED lights	<p>POWER (Green) : Lights when power is supplied from the AC adapter</p> <p>LINK (Yellow) : Lights when the HDC-RH100-D or HDBaseT product is connected</p> <p>Blinks (0.5 second-interval) when the destination is in standby state</p> <p>LAN and RS-232C communications are available</p> <p>Turns off when no connection</p> <p>HDCP (Yellow) : Lights when there is an access to HDCP</p> <p>Blinks when there is no access to HDCP</p> <p>Turns off when no input signals are recognized</p>
⑥	LAN connector	Connector for LAN signals
⑦	RS-232C connector	Connector for RS-232C signals 【See: 7.1 RS-232C pin assignment】
⑧	AC adapter connector	Connector for the supplied AC adapter 【See: 6.2.8 AC adapter with screw locking mechanism】
⑨	Frame ground	Use for bonding chassis to local ground. An M3 screw is used.

5.2 Receiver (HDC-RH100-D)

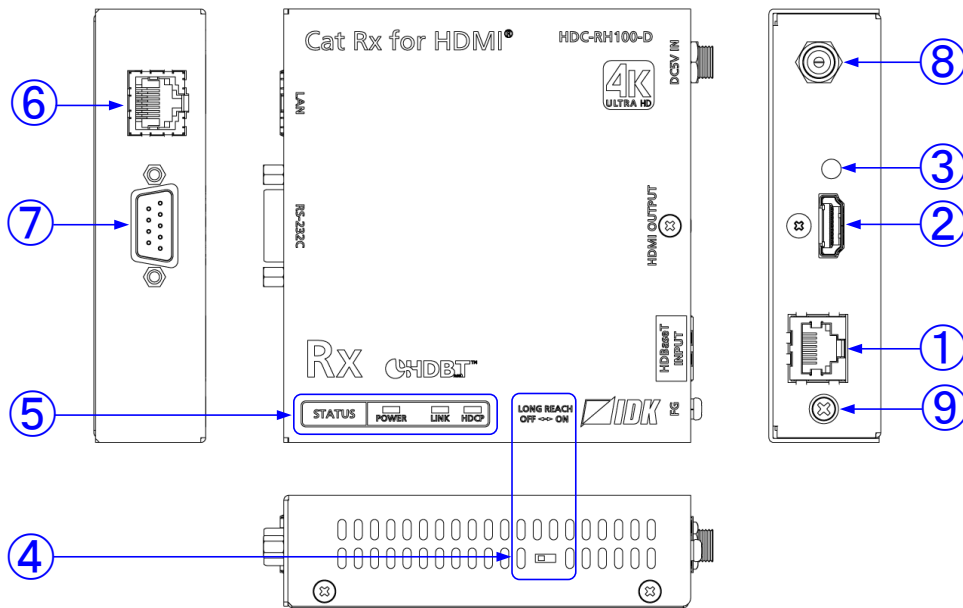

[Fig. 5.2] Receiver drawing

[Table 5.2] Receiver features

[1/2]

#	Feature	Description
①	HDBaseT input connector	Input connector for HDBaseT signal Connects to HDC-TH100-D or HDBaseT product
②	HDMI output connector	Output connector for HDMI and DVI signal, interfaces with sink devices such as LC monitors
③	HDMI cable fixing hole (Not used)	Not used.
④	Long reach mode setting switch	Enables/disables long reach mode of HDBaseT input for up to 1080p (24 bit) or dot clock 148 MHz ON : Enables long reach mode (Up to 492 ft. (150 m)) OFF: Disables long reach mode (Up to 328 ft. (100 m)) *For long reach mode, use HDC-TH100-D or IDK's HDBaseT product supporting up to 328 ft. (100 m)

#	Feature	Description
⑤	LED lights	<p>POWER (Green) : Lights when power is supplied from the AC adapter. LINK (Yellow) : Lights when the HDC-TH100-D or HDBaseT product is connected Blinks (0.5 second-interval) when the destination is in standby state LAN and RS-232C communications are available Turns off when no connection</p> <p>HDCP (Yellow) : Lights when there is an access to HDCP Blinks when there is no access to HDCP Turns off when any input signals are not recognized</p>
⑥	LAN connector	Connector for LAN signals
⑦	RS-232C connector	Connector for RS-232C signals <p style="text-align: right;">【See: 7.1 RS-232C pin assignment】</p>
⑧	AC adapter connector	Connector for the supplied AC adapter <p style="text-align: right;">【See: 6.2.8 AC adapter with screw locking mechanism】</p>
⑨	Frame ground	Use for bonding chassis to local ground. An M3 screw is used.

6 Precautions

Before using HDC, follow the precautions and instructions below.

6.1 Installation

When installing the HDC, please observe the following precautions.

- Do not stack or place one HDC directly on top of another HDC.
- Do not block vent holes. To provide adequate ventilation, maintain sufficient clearances around the HDC (1.2 in. (30 mm) or more).
- When the HDC needs to be mounted in an enclosed space or an EIA rack without using IDK's rack mounting hardware (RM-SF and RM-SH), ensure that a sufficient ventilation/cooling system is provided to keep the ambient temperature at 104°F (40°C) or lower. If inadequately vented, the product's service life, operation, and reliability may be affected.

Maintain adequate clearances (1.2 in. (30 mm) or more) as shown below.

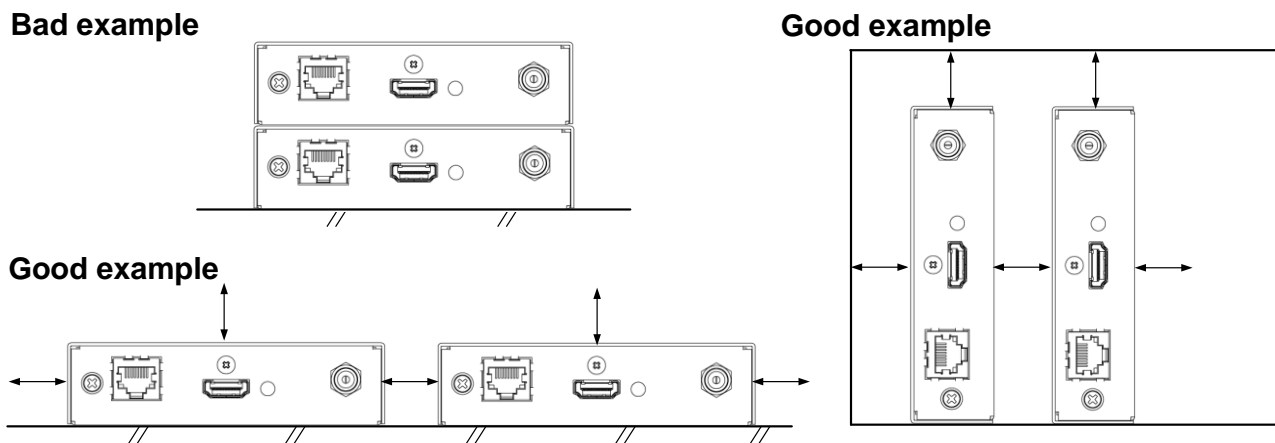

[Fig. 6.1] Necessary clearances

6.1.1 Installing on wall or ceiling

You can install the HDC on a wall or ceiling using the optional mounting plate (FP-100).

6.2 Cabling

When connecting the HDC to external devices, please observe the following precautions.

- Read manuals for the external devices.
- Before you connecting cables to the HDC or an external device, dissipate static electricity by touching grounded metal such as racks before handling signal cables. Failure to observe this precaution may result in ESD (electrostatic discharge) damage.
- Power all units off before connecting cables.
- Be sure to fully seat all plugs and connections and dress cables to reduce stress on connectors.
- Use the cable lacing bracket to secure a standard HDMI cable as shown.

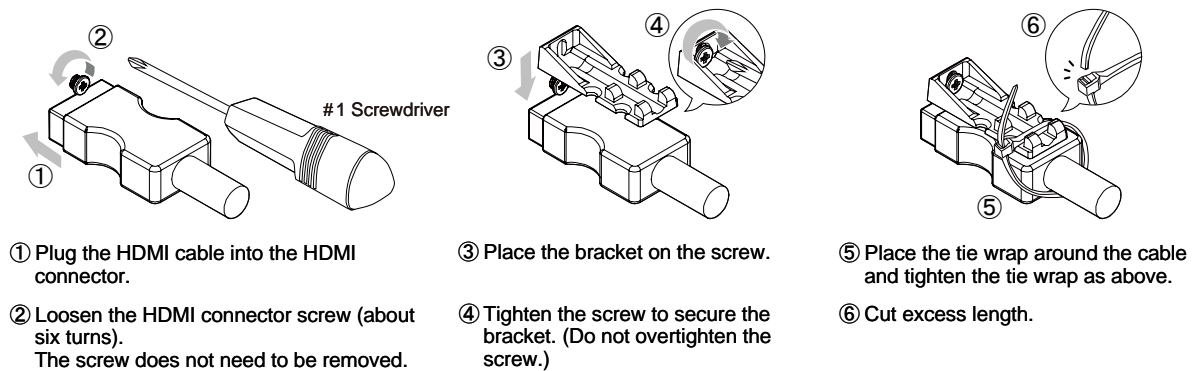

[Fig. 6.2] Cable Lacing Bracket (FB-01 For IDK products only)

6.2.1 Cables

Use the correct HDMI cable or HDMI-DVI conversion cable depending on the system configuration.

When the video is 4K format, the maximum TMDS data rate (transmission speed) is 18 Gbps. If a high-speed HDMI cable is used, the maximum TMDS data rate of 10.2 Gbps can be transferred, and the video cannot be displayed stably.

Please select an 18 Gbps high-speed cable depending on the 4K format. The maximum transmission distance depends on the cable type, source and sink devices. You are recommended to use high quality cables.

[Table 6.1] 18 Gbps high-speed cable for 4K format

4K format	TMDS data rate (Gbps)								
	RGB, YCbCr 4:4:4			YCbCr 4:2:2			YCbCr 4:2:0		
	24 bit	30 bit	36 bit	24 bit	30 bit	36 bit	24 bit	30 bit	36 bit
3840x2160p (24/25/30)	10.2 Gbps	18 Gbps	18 Gbps	10.2 Gbps	10.2 Gbps	10.2 Gbps	—	—	—
4096x2160 (24/25/30)	10.2 Gbps	18 Gbps	18 Gbps	10.2 Gbps	10.2 Gbps	10.2 Gbps	—	—	—
3840x2160p (50/59.94/60)	18 Gbps	—	—	18 Gbps	18 Gbps	18 Gbps	10.2 Gbps	18 Gbps	18 Gbps
4096x2160 (50/59.94/60)	18 Gbps	—	—	18 Gbps	18 Gbps	18 Gbps	10.2 Gbps	18 Gbps	18 Gbps

18 Gbps: 18 Gbps high-speed cable, 10.2 Gbps: 10.2 Gbps transmission cable, —:N/A

Note:

If a cable joint (JJ) or the like is used to extend the distance, the video may not be displayed correctly.

6.2.2 Category cable for extension

To ensure the best performance of category cables, select a correct category cable and connect it correctly.

- Cat5e UTP/STP and Cat6 UTP/STP can be used, but we recommend CAT.5E HDC cable* for optimal performance.
- If using an STP cable, connect the FG connector to a ground source. Otherwise, the shielding feature does not work correctly. When using a UTP cable, we still recommend using the ground connector.
- The shielded STP cables are less affected by interference or external noise than UTP cables.
- Connectors for long-haul transmission are the same as that of eight-core modular connector used for Ethernet, but the transmission system is not the same so that it cannot be connected to Ethernet.
- The maximum transmission distance of a category cables is the shorter distance of the maximum transmission distances of transmitter/receiver/sink device connected to the HDC.
- Pin assignments: T568A or T568B straight
- Do not pull the cable hard. The allowable tension of the category cable is 110 N.
- Do not bend the connection cable at a sharp angle. Keep the bend radius four times of the cable diameter or larger.
- Do not tie the cable tightly; leave a space allowing the cable to move slightly.
- If you use multiple category cables, we recommended keeping a distance between the cables or not to place the cables closely in parallel.
- Keep the category cable as straight as you can. If you coil the cable, it is easily affected by noise.
- Do not place the cable in an electrically noisy environment, since high-speed signals are transmitted. Particularly when you use a high-output radio around the HDC, video or audio may be interrupted.
- If the total transmission distance from the transmitter to receiver is 328 ft. (100 m) or less, up to two cable joints can be used. Products supporting Cat6A (10GBase-T) are recommended. The transmission distance of high-resolution transmission, such as 4K, may be shortened about 10%.
- The table below shows supported transmission distance for each category. Note that the distance may shorten depending on the actual environment.

[Table 6.2] Transmission distance

Noise influence	Category		Transmission distance	TMDS clock	Recommended cable
Easily affected	UTP	Cat5e	164 ft. (50 m)	\leq 225 MHz	For 164 ft. (50 m) or longer: CAT.5E HDC*, Cat5e STP, and Cat6 UTP/STP cables
		Cat6	328 ft. (100 m)		
				230 ft. (70 m)	
Less affected	STP	Cat5e*	328 ft. (100 m)	Long reach mode \leq 148 MHz (1080p (24 bit) or less)	For 4K format 230 ft. (70 m) or longer: CAT.5E HDC*, Cat5e STP, and Cat6 STP cables
		Cat6	492 ft. (150 m)		

* The CAT.5E HDC cable is a double-shielded category cable that optimizes video signal transmission. It is certified to 500 MHz bandwidth at distance up to 330 ft. (100 m) and verified to meet requirements specified by HDBaseT Alliance. The double-shielded structure protects video signal from outside interference.

Note:

If there is a problem in the transmission path, video or audio may be interrupted. Check the precautions above. If the problem still cannot be solved, shortening the category cable may remedy the problem.

6.2.3 LAN cable

Use a LAN cable meeting 10Base-T/100Base-TX standard.
100-Mbps Ethernet signals can be transmitted over a long distance.

6.2.4 RS-232C cable

RS-232C signals (up to 115.2 Kbps) can be transmitted bi-directionally over a long distance.
Select a cross or straight cable according to the connected devices.

【See: 7.1 RS-232C pin assignment】

6.2.5 RS-232C communication function

When designing a control program, note the following points:

- For RS-232C communication, some unnecessary data may be input to RS-232C signals when the HDC is powered off or the link is established. Some data may possibly be damaged or destroyed.
- Control by communication is not available until the link is established. Wait or retry may be needed.

6.2.6 Cascade connection

Distribution amplifiers and multi switchers that are HDCP-compliant repeaters can be connected and can be configured in a cascade connection using category cable extender supporting DVI signals. However, cascade connection is not available in the following cases:

- HDC and another set of HDC are used together.
- A repeater supporting HDCP pass through (Example: Switchers, boosters) is used.

6.2.7 DVI signals with copyright protection

The HDC does not support the long-distance transmission of DVI signals that are protected by HDCP (hereafter referred to as “DVI signals with HDCP”).

Use IDK’s HDBaseT product supporting DVI signals to transmit DVI signals with HDCP.

	With HDCP*	Without HDCP
HDMI signals	Supported	Supported
DVI signals	Not supported	Supported

* Depends on the combination of source and sink devices

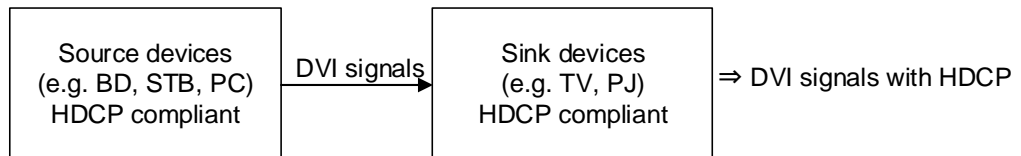

[Fig. 6.3] Configuration example of DVI signals with HDCP

If both source and sink devices have an HDMI connector, HDMI signals are output; if either or both have a DVI connector, DVI signals are output. However, even if both connectors are for HDMI, sometimes DVI signals will still be output. Note that signal type to be output cannot be determined only by connector shapes.

Example: DVI signals are output even when a projector with an HDMI connector is connected.

Some source devices will check the EDID of the projector, and if the audio is not compliant, DVI signals will be output instead of HDMI.

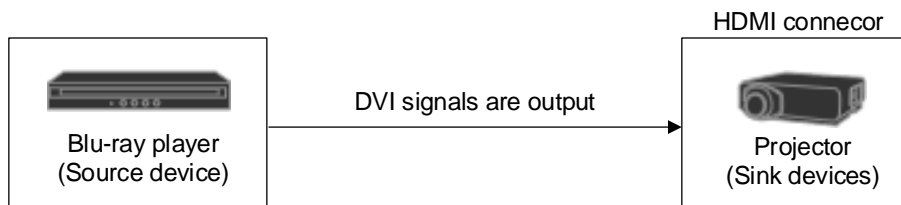

[Fig. 6.4] Example: DVI signals are output between HDMI connectors

6.2.8 AC adapter with screw locking mechanism

The shapes of AC plugs with screw locking mechanism vary from country to country. The AC plug can be removed from the AC adapter.

Removing AC plug:

Slide the AC plug (②) from the AC adapter while holding down the portion mentioned below (①).

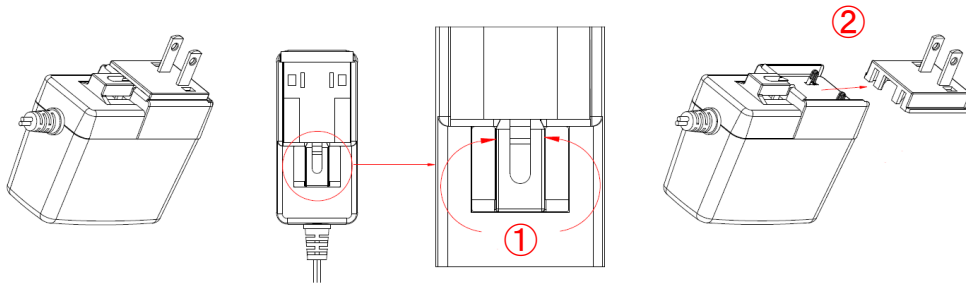

[Fig. 6.5] Removing AC plug (Example: Plug type A)

Attaching AC plug:

Gently slide the AC plug into the AC adapter (③) until it clicks (④).

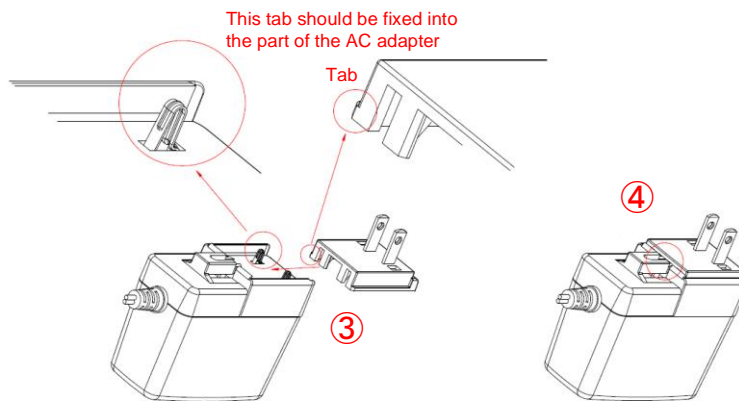

[Fig. 6.6] Attaching AC plug (Example: Plug type A)

7 Specifications

7.1 RS-232C pin assignment

Pin assignment of the RS-232C connector is as follows.

Use a cross cable or a straight cable depending on device to be connected.

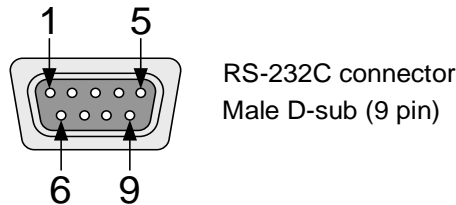

[Fig. 7.1] RS-232C pin assignment

■ Connecting HDC-H100-D to PC

Use a cross cable to connect the HDC-H100-D to a PC.

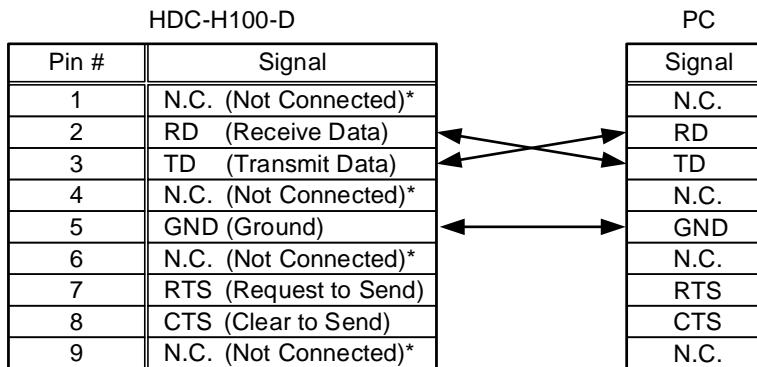

*Not used

[Fig. 7.2] RS-232C pin assignment (connecting to PC)

■ Connecting HDC-H100-D to IDK's products

Use a cross cable to connect the HDC-H100-D to an IDK's product.

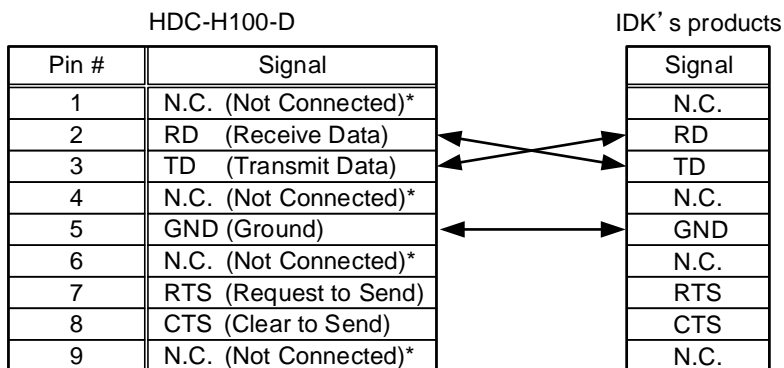

*Not used

[Fig. 7.3] RS-232C pin assignment (connecting to IDK's product)

■ Connecting HDC-H100-D to another device requiring straight connection

Use a straight cable to connect the HDC-H100-D to other devices requesting straight connection.

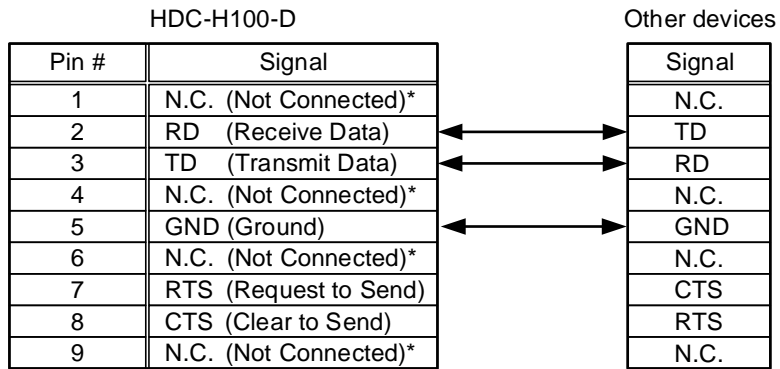

*Not used

[Fig. 7.4] RS-232C pin assignment (Connecting to device requiring straight connection)

7.2 Product specification

Item		HDC-TH100-D (Transmitter)	HDC-RH100-D (Receiver)
Input		1 input HDMI (*1)/DVI 1.0 TMDS signal link HDCP 1.4/2.2 (Pass-through) (*2) CEC (Pass-through) Connector: Female HDMI Type A (19-pin) (*3)	1 input HDBaseT RS-232C, LAN Connector: RJ-45
Output		1 output HDBaseT RS-232C, LAN Connector: RJ-45	1 output HDMI (*1)/DVI 1.0 TMDS signal link HDCP 1.4/2.2 (Pass-through) (*2) CEC (Pass-through) Connector: Female HDMI Type A (19-pin) (*3)
Format		VGA to 4K (*4) 480i / 480p / 576i / 576p / 720p / 1080i / 1080p / 4K (*4)	
Color depth		24 bit, 30 bit, 36 bit Deep Color (*5)	
Dot clock		25 MHz to 600 MHz	
TMDS clock		25 MHz to 340 MHz	
TMDS data rate		0.75 Gbps to 10.2 Gbps	
Plug & Play		Pass-through	
Digital audio input/output		Multi-channel LPCM up to 8 channels Sampling frequency: 32 kHz to 192 kHz, Sample size: 16 bit to 24 bit	
Cable for extension	Cable (*6)	CAT.5E HDC, Cat5e UTP/STP, Cat6 UTP/STP cable	
	Maximum transmission distances (*7)	328 ft. (100 m) (For 4K format, CAT.5E HDC, Cat5e STP, or Cat6 STP cable is used) 492 ft. (150 m) (Long reach mode is used)	
External control	RS-232C	1 port/male D-sub (9 pin), full duplex, up to 115.2 kbps	
	LAN	1 port/RJ-45 10Base-T/100Base-TX (Auto Negotiation), Auto MDI/MDI-X	
General	Power	DC 5 V 0.8 A	DC 5 V 1.4 A
	Power consumption	About 4 W	About 7 W
	Dimensions	4.2 (W) x 1.1 (H) x 3.9 (D)" (106 (W) x 27.5 (H) x 100 (D) mm) (Quarter rack wide, thin type) (Excluding connectors and the like)	
	Weight	0.4 lbs. (0.2 kg)	
	Temperature	Operating : 32°F to 104°F (0°C to +40°C) Storage : -4°F to +176°F (-20°C to +80°C)	
Humidity	Operating/Storage: 20% to 90% (Non Condensing)		

*1 HEC and ARC are not supported.

*2 To transmit those signals, use an IDK's HDBaseT product supporting DVI signals.
If DVI signals with HDCP is sent from the source device, video may not be output to the sink device. Please check the operation beforehand.

*3 Use 16 ft. (5 m) or shorter HDMI cables.

For 4K format, use an 18-Gbps high speed cable.

*4 For 4K format, 24 Hz/25 Hz/30 Hz/50 Hz (4:2:0)/59.94 Hz (4:2:0)/60 Hz (4:2:0) are supported.

*5 For 4K format, the following color depths are supported.

- 24 Hz/25 Hz/30 Hz : 4 bit (RGB, YCbCr 4:4:4)
- 24 Hz, 30 bit, 36 bit (YCbCr 4:2:2)
- 50 Hz/59.94 Hz/60 Hz : 24 bit (YCbCr 4:2:0)

*6 T568A or T568B straight. The CAT.5E HDC cable is developed by IDK and recommended by HDBaseT alliance.

*7 The maximum transmission distance was obtained when IDK's CAT.5E HDC cable was used. The distance may not be extended with some device combinations, cabling method, or other manufacturer's cable. Video may be disturbed or may not be output even if signals are within the range mentioned above. Operations may not be stable with some LCD devices; please check the operation beforehand or contact us.

The maximum transmission distance is the shorter distance of connected HDBaseT product or sink device's maximum transmission distance.

For Long reach mode, use IDK's category cable products that supports 328 ft. (100 m), and up to resolutions 1080p (24 bit) or less are supported.

8 Troubleshooting

In case the HDC does not work correctly, please check the following items first. Also refer to manuals for connected devices as well, since they may possibly be the cause of the problem.

- Are the HDC and all devices plugged in and powered on normally?
- Are cables connected correctly?
- Are there no loose connections?
- Are correct cables for HDC being used?
- Are signal specifications of connected devices matched to each other?
- Are settings of the sink device correct?
- Are there any nearby objects that may cause noise?

If additional assistance is required, please check the following items and then contact us.

No.	Checking items	Result
1	The same problem occurs at all connectors?	Yes or No
2	Operates correctly when connect devices using genuine cables without connecting of HDC?	Yes or No

User Guide of HDC-TH100-D/HDC-RH100-D

Ver.1.8.0

Issued on: 8 August 2023



Headquarters

IDK Corporation
7-9-1 Chuo, Yamato-shi, Kanagawa-pref.
242-0021 JAPAN
TEL: +81-46-200-0764 FAX: +81-46-200-0765

Email: idk_eng@idk.co.jp

URL: www.idkav.com

USA

IDK America Inc.
72 Grays Bridge Road Suite 1-C, Brookfield, CT 06804
TEL: +1-203-204-2445

Email: sales@idkav.com

URL: www.idkav.com

Europe

IDK Europe GmbH
Lise-Meitner-Str. 6, D-40878 Ratingen
TEL: +49-2102-578-301-0

Email: info@idkav.eu

URL: www.idkav.com



Product information Support

Arvanics Corporation
7-9-1 Chuo, Yamato-shi, Kanagawa-pref.
242-0021 JAPAN
TEL: +81-46-259-6920 FAX: +81-46-259-6930

Email: info@arvanics.com

URL: www.arvanics.com

Information in this document is subject to change without notice.

©2018 IDK Corporation, all rights reserved. All trademarks mentioned are the property of their respective owners.