

HDMI Transceiver

NJR-P01Ux-TR Series

NJR-P01UF-TR/NJR-P01UC-TR

User Guide

Ver.1.1.0



Thank you for choosing our product.

To ensure the best performance of this product, please read this user guide fully and carefully before using it and keep this manual together with the product for future reference as needed.

- All rights reserved.
- Some information contained in this guide such as exact product appearance, communication commands, and so on may differ depending on the product version.
- This guide is subject to change without notice. You can download the latest version from IDK’s website at: www.idkav.com

About technical documentation

■ **Please read the following guides before connecting this equipment to a power source.**

<p>1. Safety Instructions Contains important safety instructions for the product to help ensure your own personal safety and protect the product and working environment from potential damage.</p>	<p>Provided with the product.</p>
<p>2. Setup Guide Contains setup information and precautions for installing the product and connecting cables.</p>	<p>Download from www.idkav.com</p>

■ **Please refer to the following guides as needed.**

<p>3. Operation Guide Describes how to configure and use the equipment.</p>	<p>Download from www.idkav.com</p>
<p>4. User Guide Contains detailed explanation of functions, setting values, and restrictions.</p>	<p>www.idkav.com</p>

Trademarks

- HDBaseT™ and the HDBaseT Alliance Logo are trademarks of the HDBaseT Alliance.
- The terms HDMI and HDMI High-Definition Multimedia Interface, and the HDMI Logo are trademarks or registered trademarks of HDMI Licensing Administrator, Inc. in the United States and other countries.
- SDVoE™ and SDVoE logo are trademarks of SDVoE Alliance.
- All other company and product names mentioned in this document are either registered trademarks or trademarks of their respective owners. In this document, the “®” or “™” marks may not be specified.
- ©2023 IDK Corporation, all rights reserved.

FCC STATEMENT

Note: This equipment has been tested and found to comply with the limits for a Class A digital device, pursuant to part 15 of the FCC Rules. These limits are designed to provide reasonable protection against harmful interference when the equipment is operated in a commercial environment. This equipment generates, uses, and can radiate radio frequency energy and, if not installed and used in accordance with the instruction manual, may cause harmful interference to radio communications. Operation of this equipment in a residential area is likely to cause harmful interference, in which case the user will be required to correct the interference at his own expense.

(Class A)

**Supplier’s Declaration of Conformity
47 CFR § 2.1077 Compliance Information**

Unique Identifier

Type of Equipment: HDMI Transceiver
Model Name: NJR-P01UF-TR, NJR-P01UC-TR

Responsible Party – U.S. Contact Information

Company Name: IDK America Inc.
Address: 72 Grays Bridge Road Suite 1-C, Brookfield, CT 06804
Telephone number: +1-203-204-2445
URL: www.idkav.com

FCC Compliance Statement

This device complies with Part 15 of the FCC Rules. Operation is subject to the following two conditions:
(1) This device may not cause harmful interference, and (2) this device must accept any interference received, including interference that may cause undesired operation.

(FCC SDoC)

CE MARKING

This equipment complies with the essential requirements of the relevant European health, safety and environmental protection legislation.

WEEE MARKING











Waste Electrical and Electronic Equipment (WEEE), Directive 2002/96/EC
(This directive is only valid in the EU.)
This equipment complies with the WEEE Directive (2002/96/EC) marking requirement.
The left marking indicates that you must not discard this electrical/electronic equipment in domestic household waste.

Safety Instructions

Read all safety and operating instructions before using this product. Follow instructions and heed warnings/cautions.

Instructions and warnings/cautions for all products are provided. Some of them may not be applicable to your product.

	<h2 style="margin: 0;">Warning</h2>	Indicates the presence of a hazard that may result in death or serious personal injury if the warning is ignored or the product is handled incorrectly.
	<h2 style="margin: 0;">Caution</h2>	Indicates the presence of a hazard that may cause minor personal injury or property damage if the caution is ignored or the product is handled incorrectly.

Symbol	Description	Example
 Caution	This symbol is intended to alert the user. (Warning and caution)	 Hot surfaces Caution
 Prohibited	This symbol is intended to prohibit the user from specified actions.	 Do not disassemble
 Instruction	This symbol is intended to instruct the user.	 Unplug

Warning

For lifting heavy products:

 Instruction	<ul style="list-style-type: none"> ● Lifting must be done by two or more personnel. <p>To avoid injury: When lifting the product, bend your knees, keep your back straight and get close to it with two or more persons.</p>
--	--





For installing and connecting products:

 Prohibited	<ul style="list-style-type: none"> ● Do not place the product in unstable place. <p>Install the product in a horizontal and stable place, as this may fall or tip over and cause injury.</p> <ul style="list-style-type: none"> ● Secure the product if installing in the locations with vibration. <p>Vibration may move or tip over the product unexpectedly, resulting in injury.</p>
---	--

Warning

 Instruction	<ul style="list-style-type: none"> ● Installation work must be performed by professionals. The product is intended to be installed by skilled technicians. For installation, please contact a system integrator or IDK. Improper installation may lead to the risk of fire, electric shock, injury, or property damage. ● Insert the power plug into an outlet that is unobstructed. Unobstructed access to the plug enables unplugging the product in case of any extraordinary failure, abnormal situation or for easy disconnection during extended periods of non-use. ● Insert the power plug into an appropriate outlet completely. If the plug is partially inserted, arcing may cause the connection to overheat, increasing the risk of electric shock or fire. Do not use a damaged plug or connect to a loose outlet. ● Unplug the product from an AC power source during installation or service. When connecting peripheral devices to this product, unplug all involved devices from outlets. Ground potential differences may cause fire or other difficulties. ● The product must be electrically earthed/grounded. To reduce the risk of electric shock, ensure the product is connected to a mains socket outlet with a protective earthing connection. ● For PoE/PoH, use category cables meeting IEEE802.3af/at. Otherwise, it may cause problems or a fire.
---	--

For operating products:

 Prohibited	<ul style="list-style-type: none"> ● Keep out any foreign objects. To avoid fire or electric shock, do not permit foreign objects, such as metal and paper, to enter the product from vent holes or other apertures. ● For power cable/plug and Category cable, <ul style="list-style-type: none"> • Do not scratch, heat, or modify, including splicing or lengthening them. • Do not pull, place heavy objects on them, or pinch them. • Do not bend, twist, tie or clamp them together forcefully. <p>Misuse of the power cable and plug may cause fire or electric shock. If power cables/plugs become damaged, contact your IDK representative.</p>
 Do not disassemble	<ul style="list-style-type: none"> ● Do not repair, modify or disassemble. Since the product includes circuitry that uses potentially lethal, high voltage levels, disassembly by unauthorized personnel may lead to the risk of fire or electric shock. For internal inspection or repair, contact your IDK representative.
 Do not touch	<ul style="list-style-type: none"> ● Do not touch the product and connected cables during electric storms. Contact may cause electric shock.
 Instruction	<ul style="list-style-type: none"> ● Clean the power plug regularly. If the plug is covered in dust, it may increase the risk of fire.



If the following problem occurs:

 Unplug	<ul style="list-style-type: none"> ● Unplug immediately if the product smokes, makes unusual noise, or produces a burning odor. ● Unplug immediately if the product is damaged by falling or having been dropped. ● Unplug immediately if water or other objects are directed inside. <p>If you continue to use the product under these conditions, it may increase the risk of electric shock or fire. For maintenance and repair, contact your IDK representative.</p>
--	--







Caution

For installing and connecting products:

 <p>Prohibited</p>	<ul style="list-style-type: none"> ● Do not place the product in a location where it will be subjected to high temperatures. If the product is subjected to direct sunlight or high temperatures while under operation, it may affect the product's performance and reliability and may increase the risk of fire. ● Do not store or operate the product in dusty, oil smoke filled, or humid place. Placing the product in such environment may increase the risk of fire or electric shock. ● Do not block the vent holes. If ventilation slots are blocked, it may cause the product to overheat, affecting performance and reliability and may increase the risk of fire. ● Do not place or stack heavy items on the product. Failure to observe this precaution may result in damage to the product itself as well as other property and may lead to the risk of personal injury. ● Do not exceed ratings of outlet and wiring devices. Exceeding the rating of an outlet may increase the risk of fire and electric shock.
 <p>No wet hands</p>	<ul style="list-style-type: none"> ● Do not handle power plug with wet hands. Failure to observe this precaution may increase the risk of electric shock.
 <p>Instruction</p>	<ul style="list-style-type: none"> ● Use and store the product within the specified temperature/humidity range. If the product is used outside the specified range of temperature and humidity continuously, it may increase the risk of fire or electric shock. ● Do not place the product at elevations of 1.24 mi. (2,000 m) or higher above sea level. Failure to do so may shorten the life of the internal parts and result in malfunctions. ● When mounting the product into the rack, provide sufficient cooling space. Mount the product in a rack meeting EIA standards, and maintain spaces above and below for air circulation. For your safety as required, attach an L-shaped bracket in addition to the panel mount bracket kit to improve mechanical stability. ● Never insert screws without the rubber feet into the threaded holes on the bottom of the product. Never insert screws alone into the threaded holes on the bottom of the product. Doing so may lead to damage when the screws contact electric circuitry or components inside the product. Reinstall the originally supplied rubber feet using the originally supplied screws only.

For operating products:

 <p>Hot surfaces Caution</p>	<p>For products with the hot surfaces caution label only:</p> <ul style="list-style-type: none"> ● Do not touch the product’s hot surface. <p>If the product is installed without enough space, it may cause malfunction of other products. If you touch product’s hot surface, it may cause burns.</p>
 <p>Prohibited</p>	<ul style="list-style-type: none"> ● Use only the supplied power cable and AC adapter. ● Do not use the supplied power cable and AC adapter with other products. <p>If non-compliant adapter or power cables are used, it may increase the risk of fire or electric shock.</p>
 <p>Unplug</p>	<ul style="list-style-type: none"> ● If the product won’t be used for an extended period of time, unplug it. <p>Failure to observe this precaution may increase the risk of fire.</p> <ul style="list-style-type: none"> ● Unplug the product before cleaning. <p>To prevent electric shock.</p>
 <p>Instruction</p>	<ul style="list-style-type: none"> ● Do not prevent heat release. <p>If cooling fan stops, power off the product and contact IDK. Failure to do so may raise internal temperature and increase the risk of malfunction, fire, or electric shock.</p> <ul style="list-style-type: none"> ● Keep vents clear of dust. <p>If the vent holes near the cooling fan or near the fan are covered with dust, internal temperatures increase and may increase the risk of malfunction. Clean the vent holes and near the fan as needed. If dust accumulates inside of the product, it may increase the risk of fire or electric shock. Periodic internal cleaning, especially before humid rainy season, is recommended. For internal cleaning, contact your IDK representative.</p>

Contents

About this Guide	9
Conventions	9
About this Product	10
Setting	11
DIP switch	11
Stopping sending device detection packet	11
Disabling HDCP or EDID settings	12
Input	13
Hot plug output for when there is no active video input signal	13
HDCP input	15
Output	16
Signal format	16
Switching mode	16
Output resolution	17
HDCP authentication	17
Hot plug ignoring duration	18
Output audio	19
Mute	19
Audio mute duration	19
Output audio selection	19
EDID	20
EDID selection	20
Resolution	21
Copying EDID	21
Deep Color	22
Audio format	22
Speaker configuration	23
RS-232C	24
Communication setting	24
LAN	25
Network	25
MAC address	25
Advanced settings	26
IR control	26
USB mode	26
Fan speed	26
Status	26
Factory default list	27
Specification	28
Product specification	28
Supported video signals	30
Troubleshooting	31

About this Guide

This guide describes features, notes, and configurations of the NJR-P HDMI Transceiver.

Conventions

- The following symbols are used in this guide.
 - [] : Setting values displayed on the front panel and WEB GUI
 - “ ” : Reference
- The following notifications are used in this guide.
 - Note** : Addresses practices not related to personal injury, such as restrictions and attention.

About this Product

The NJR-P01UF-TR/NJR-P01UC-TR is a transceiver for transmitting and receiving 4K@60 HDMI signals simultaneously over a 10GbE AV over IP network via fiber optic cables or twisted pair cables. Bidirectional RS-232C communication, LAN, USB (HID) such as KVM can be carried over the same fiber optic cable or twisted pair cable for extension.

Additionally, via the NJR, the NJR-CTB can be controlled using an IR cable (IR-P01-R) and recommended remote controller.

The NJR-P01UC-TR can be powered via PoE-supported 10GbE switch over a twisted pair cable; this feature eliminates the need for AC adapter.

This product can be used in combination with IDK's SDVoE supported products.

Setting

The NJR-P can be set using the IP-NINJAR Configurator or NJR-CTB.

Set “**Stopping sending device detection packet (P.11)**” to [OFF]. If it is set to [ON], IP-NINJAR Configurator or NJR-CTB is not detected.

The table below is used in this chapter.

Example:

Item	NO INPUT MONITORING
For	HDMI IN
Value	OFF, 2s to 15s (10s) (by 1s) Default value is shaded.

DIP switch

[OFF] : Set a DIP switch to the upper position.

[ON] : Set a DIP switch to the down position.

Note

Set DIP switches No.1 and No.4 to [OFF] at all times.

Stopping sending device detection packet

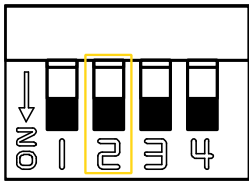

Item	Stopping sending device detection packet
Value	DIP switch No.2 OFF, ON

[OFF] : Sends device detection packet.

[ON] : Does not send device detection packet.

The NJR-P automatically sends device detection packet to LAN periodically. To not send unnecessary packet to LAN, set DIP switch No.2 to [ON].

Note

If DIP switch No.2 is set to [ON], the IP-NINJAR Configurator or NJR-CTB cannot detect the NJR-P.

Disabling HDCP or EDID settings

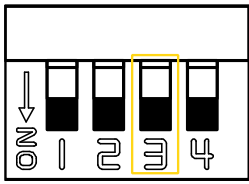

Item	Disabling HDCP or EDID settings
For	HDMI OUT, HDMI IN
Value	DIP switch No.3 OFF, ON

[OFF] : Enables settings of “**HDCP authentication (P.17)**” and “**EDID selection (P.20)**”.

[ON] : Disables settings of “**HDCP authentication (P.17)**” and “**EDID selection (P.20)**”. Settings below will be applied.

HDCP authentication : HDCP INPUT ONLY

EDID selection : EXTERNAL EDID

Input

Hot plug output for when there is no active video input signal

The NJR-P requests the source device to output video signal by sending hot plug when no active video input signal is input. You can enable/disable this feature and set the request interval.

Item	NO INPUT MONITORING
For	HDMI IN
Value	OFF, 2s to 15s (10s) (by 1s)

[OFF] : Does not request the source device to output video signal even if there is no active input signal.

[2s] to [15s] : Requests the source device to output video signal after the specified monitoring time if there is no active input signal.

If the NJR-P is powered on or EDID is changed with the connected source device is powered on, the source device may stop outputting video signal. In this case, use this feature to request the source device to output video signal.

■ Example: Video signal is output within the specified monitoring time

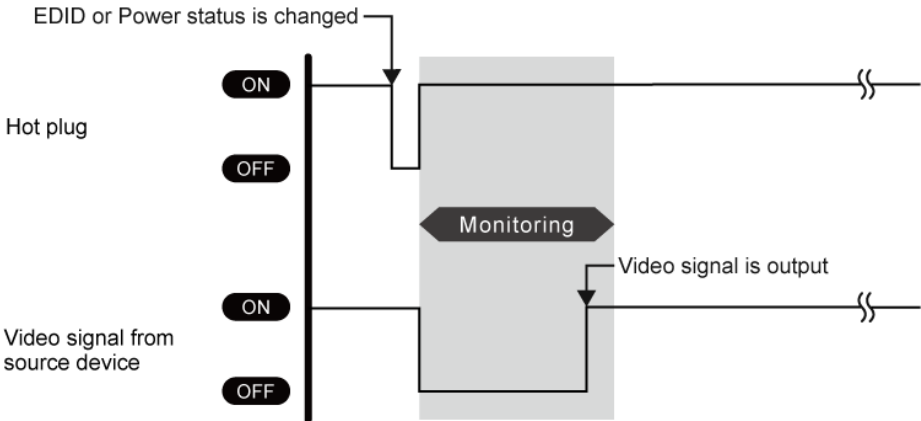

■ Example: The source device stops outputting video signals → Hot plug request is needed.

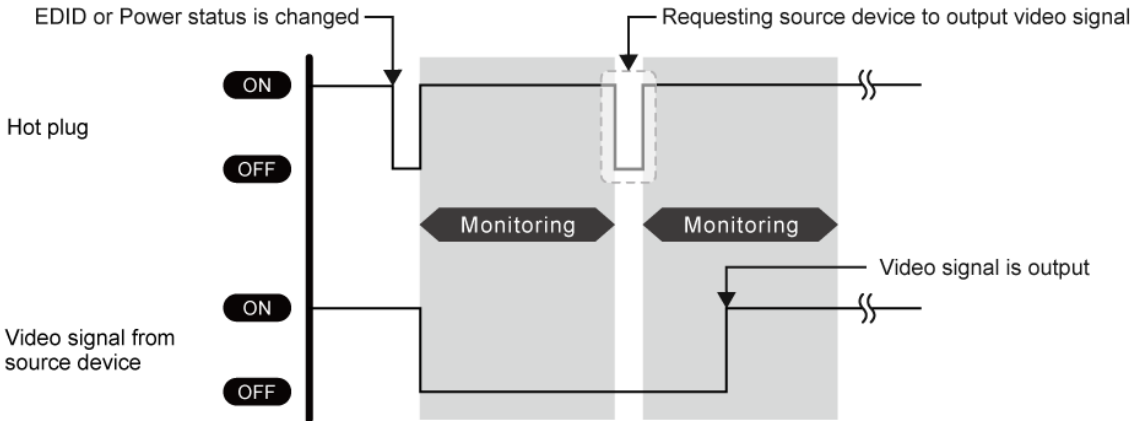

■ **Example: The specified monitoring time is too short. → Set the longer monitoring time.**

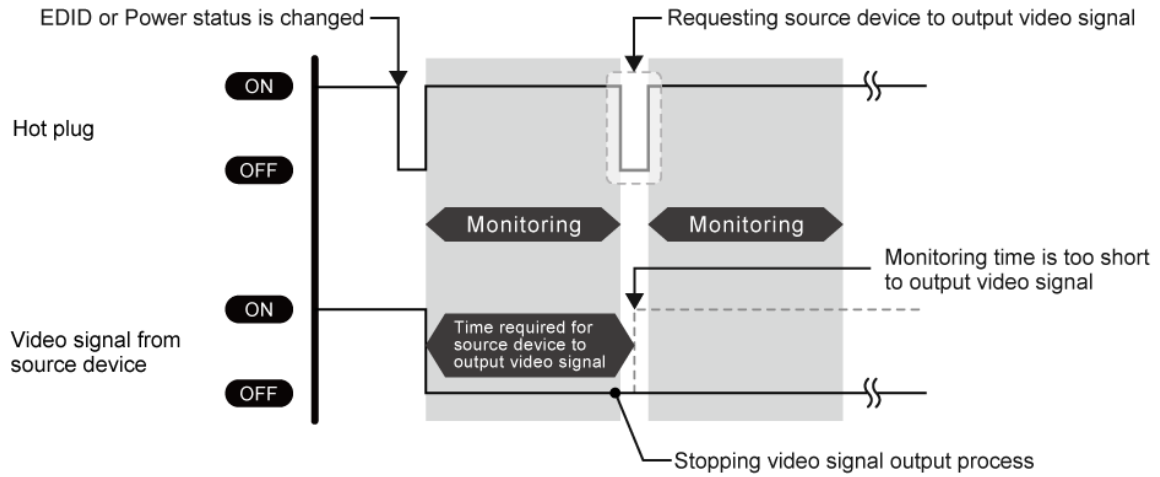

If the interval is shorter than the time for source device output video signal, the source device repeats the video output process and does not output video signal. This problem can be solved by setting longer monitoring time.

Note

If the source device, such as a PC, disables the monitor power-saving or dual monitor features, set this setting to [OFF].

HDCP input

Item	HDCP INPUT
For	HDMI IN
Value	HDCP 2.2 SUPPORT, HDCP 1.4 SUPPORT, NOT SUPPORT

[HDCP 2.2 SUPPORT] : Operates as an HDCP 2.2 supported device.
 [HDCP 1.4 SUPPORT] : Operates as an HDCP 1.4 supported device.
 [NOT SUPPORT] : Operates as a non-HDCP compliant device

Some source devices negotiate with the connected device to determine if HDCP encryption is supported. After this negotiation, the source device determines whether HDCP signal encryption is enforced or not. This process takes place with some source device, even if the content being presented is not copyright protected. The NJR-P is HDCP compliant, if it is connected to a display device that does not support HDCP, unprotected AV content may not be successfully displayed. Under these circumstances and if the content is indeed not protected, the problem can be solved by setting this menu to [NOT SUPPORT].

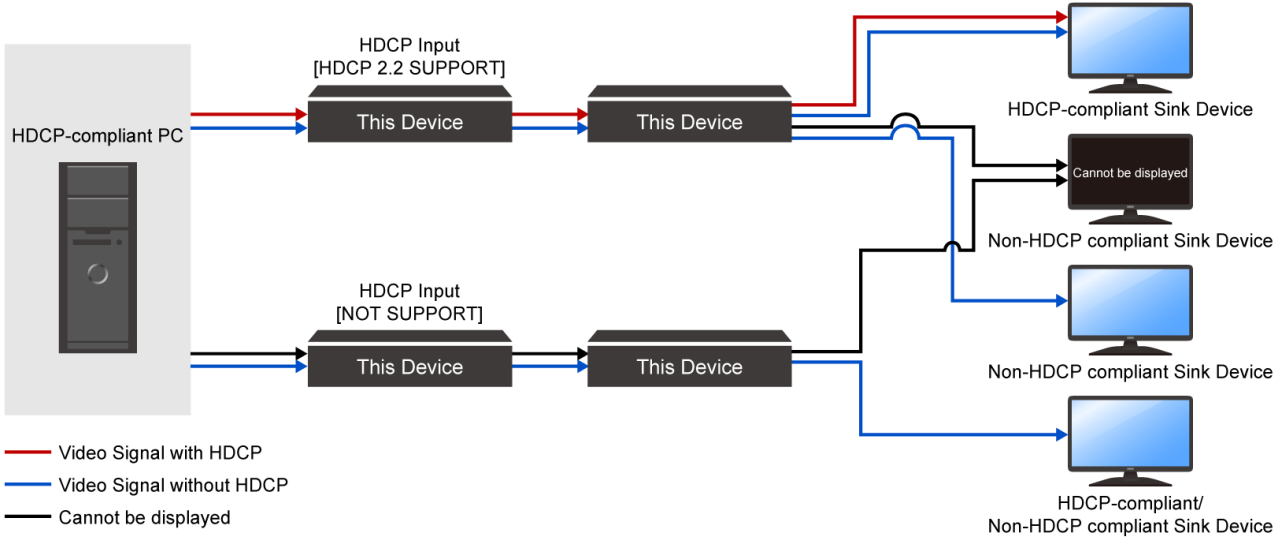

Note

HDCP 2.2 Type 0 video can be displayed on sink devices supporting HDCP 1.4.
 HDCP 2.2 Type 1 video can be displayed on sink devices supporting HDCP 2.2 but cannot be displayed on sink devices supporting HDCP 1.4.

Output

Signal format

Item	SIGNAL FORMAT
For	HDMI OUT, SDVoE OUT
Value	AUTO, YCbCr 4:4:4, YCbCr 4:2:2, YCbCr 4:2:0, RGB, DVI

[AUTO] : Outputs video signals at the optimal color space of the connected device.

[YCbCr 4:4:4] : HDMI YCbCr 4:4:4 has the highest priority.

[YCbCr 4:2:2] : HDMI YCbCr 4:2:2 has the highest priority.

[YCbCr 4:2:0] : YCbCr 4:2:0 has the highest priority.

Enabled only if input signal resolution is set to 4K@50/59.94/60. If the input signal resolution is 4K@30 or lower or if the sink device does not support HDMI YCbCr 4:2:0, [AUTO] is applied.

[RGB] : HDMI RGB has the highest priority.

[DVI] : Enabled only for resolutions 4K@30 or lower.

Note

If DVI signal is output, digital audio is not output.

Switching mode

You can set the video signal output from the HDMI output connector.

Item	SWITCHING MODE
For	HDMI OUT
Value	STANDARD, FAST & SCALE

[STANDARD] : Transmission delay is about 120 μ s. If no video signal is input from a decoder, no video signal is output from the HDMI output connector. If video signal of the same encoder is output to multiple decoders, all output video signals are synchronized.

[FAST & SCALE] : Transmission delay is two frames or less. The video signal of the set in “**Output resolution (P.17)**” is always output from the HDMI output connector. The input video signal switching via network can be performed without noise.

Output resolution

You can set the output video resolution for when “**Switching mode (P.16)**” is set to [FAST & SCALE].

Item	RESOLUTION		
For	HDMI OUT		
Value	4096x2160 60Hz 4096x2160 50Hz 4096x2160 30Hz 4096x2160 24Hz 3840x2160 60Hz 3840x2160 50Hz 3840x2160 30Hz 3840x2160 24Hz	1080p 60Hz 1080p 59.94Hz 1080p 50Hz 720p 60Hz 720p 59.94Hz 720p 50Hz	2560x1600 (WQXGA) 2560x1440 (WQHD) 2048x1152 (QWXGA) 1920x1200 (WUXGA) 1920x1080 (VESAHD) 1680x1050 (WSXGA+) 1600x1200 (UXGA) 1600x900 (WXGA++) 1440x900 (WXGA+) 1400x1050 (SXGA+) 1366x768 (WXGA) 1360x768 (WXGA) 1280x1024 (SXGA)

[4096x2160]/[3840x2160]/[1080p]/[720p]: Meets CTA-861.

Other resolutions: Meets VESA DMT/VESA CVT.

[2560x1600]/[2560x1440]/[2048x1152]/[1920x1200]/[1920x1080]: Reduced Blanking

HDCP authentication

Item	HDCP AUTHENTICATION
For	HDMI OUT
Value	HDCP 2.2, HDCP INPUT ONLY, ALWAYS

[HDCP 2.2] : HDCP 2.2 authentication

[HDCP INPUT ONLY] : HDCP 2.2 or HDCP 1.4 authentication depending on the sink device

Outputs signal depending on HDCP presence of input signal.

If input signal is protected by HDCP, outputs signal with HDCP.

If input signal is not protected by HDCP, outputs signal without HDCP.

[ALWAYS] : HDCP 2.2 or HDCP 1.4 authentication depending on the sink device

For a sink device that is not supported by HDCP, video is displayed only if this setting is set to a value other than [HDCP 2.2] and input signal is not supported by HDCP.

If [HDCP INPUT ONLY] is set, HDCP presence of output signal changes depending on HDCP presence of input signal. Some sink devices may not be displayed temporarily.

To enable this setting, set “**Disabling HDCP or EDID settings (P.12)**” of DIP switch No.3 to [OFF].

Hot plug ignoring duration

You can set the duration for ignoring video output request signals that are sent from the sink device.

Item	HOTPLUG MASK
For	HDMI OUT
Value	OFF, 2s to 15s

[OFF] : Always receives video output request signals from sink devices.

[2s] to [15s] : After receiving video output request signals, ignores these signals during the specified period.

If the signal request is repeated in a short cycle, the NJR-P resets the video output process. As a result, video may not be output. This problem can be solved by setting the ignoring duration.

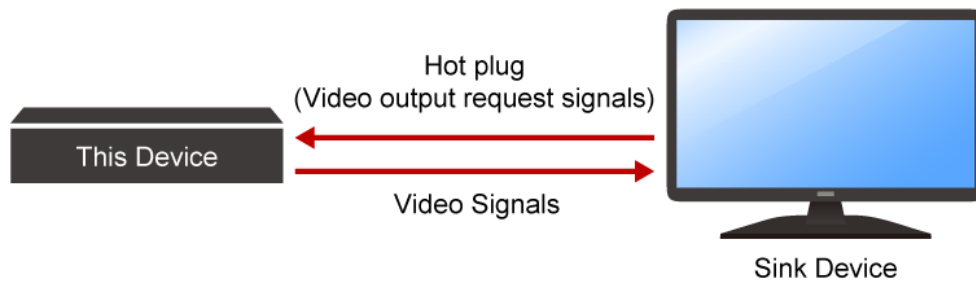

Output audio

Mute

You can mute/unmute the output audio.

Item	MUTE
For	HDMI OUT, SDVoE OUT
Value	ON (Muted), OFF

Audio mute duration

When input audio signal is switched, audio mute is enabled to prevent audio noise. You can set how long the mute status keeps.

For some sink devices, noise occurs after input audio signal is switched. If connecting these sink devices, set this menu.

Item	AUDIO MUTE TIME
For	HDMI OUT
Value	0ms to 5000ms (600ms) (by 1ms)

Output audio selection

You can select the audio (digital or analog input audio) that is output from the HDMI or output connector.

Analog input audio is available when using IP-NINJAR encoder or transceiver that has analog audio input.

Item	DIGITAL AUDIO, ANALOG AUDIO
For	HDMI OUT, AUDIO OUT
Value	DIGITAL, ANALOG (DIGITAL AUDIO: DIGITAL, ANALOG AUDIO: ANALOG)

EDID

EDID can be set using the following data:

A source device that is connected to an HDMI input connector obtains information of supported video and audio signals from the EDID. You can change the information to be sent to a source device.

To enable this setting, set “**Disabling HDCP or EDID settings (P.12)**” of DIP switch No.3 to [OFF].

EDID selection

You can set the EDID that will be sent to source device.

Item	EDID SELECTION
For	HDMI IN
Value	BUILT-IN EDID, EXTERNAL EDID, COPY DATA

[BUILT-IN EDID] : Uses built-in EDID. You can change the following EDID information:

 【Resolution (P.21)】

 【Deep Color (P.22)】

 【Audio format (P.22)】

 【Speaker configuration (P.23)】

[EXTERNAL EDID] : Receives the EDID of sink device that is connected to the decoder of the SDVoE output.

 If EDID reading fails, the EDID is not changed.

[COPY EDID] : Uses EDID that is saved to the NJR-P in “**Copying EDID (P.21)**”.

Note

If HDR signal is used, set this menu to [EXTERNAL EDID] or copy EDID of the sink device supporting HDR signals and set this menu to [COPY DATA].

Resolution

You can set the resolution of the NJR-P for if “EDID selection (P.20)” is set to [BUILT-IN EDID].

Item	RESOLUTION
For	HDMI IN
Value	See the table below. 3840x2160@60Hz 4:4:4

Resolution Value	Resolution																								
	640x480	800x600	1024x768	1280x720	1280x768	1280x800	1280x960	1280x1024	1360x768	1366x768	1400x1050	1440x900	1600x900	1600x1200	1680x1050	1920x1080	1920x1200	2048x1152	2560x1440	2560x1600	3840x2160 (30Hz)	4096x2160 (30Hz)	3840x2160 (60Hz)	4096x2160 (60Hz)	
800x600 (SVGA)	Y	Y	N	N	N	N	N	N	N	N	N	N	N	N	N	N	N	N	N	N	N	N	N	N	N
1024x768 (XGA)	Y	Y	Y	N	N	N	N	N	N	N	N	N	N	N	N	N	N	N	N	N	N	N	N	N	N
1280x720 (VESA720)	Y	Y	Y	Y	N	N	N	N	N	N	N	N	N	N	N	N	N	N	N	N	N	N	N	N	N
720p	Y	Y	N	Y	N	N	N	N	N	N	N	N	N	N	N	N	N	N	N	N	N	N	N	N	N
1280x768 (WXGA)	Y	Y	Y	Y	Y	N	N	N	N	N	N	N	N	N	N	N	N	N	N	N	N	N	N	N	N
1280x800 (WXGA)	Y	Y	Y	Y	Y	Y	N	N	N	N	N	N	N	N	N	N	N	N	N	N	N	N	N	N	N
1280x960 (QuadVGA)	Y	Y	Y	Y	Y	Y	Y	N	N	N	N	N	N	N	N	N	N	N	N	N	N	N	N	N	N
1280x1024 (SXGA)	Y	Y	Y	Y	Y	Y	Y	Y	N	N	N	N	N	N	N	N	N	N	N	N	N	N	N	N	N
1360x768 (WXGA)	Y	Y	Y	Y	Y	Y	Y	Y	Y	N	N	N	N	N	N	N	N	N	N	N	N	N	N	N	N
1366x768 (WXGA)	Y	Y	Y	Y	Y	Y	Y	Y	Y	Y	N	N	N	N	N	N	N	N	N	N	N	N	N	N	N
1400x1050 (SXGA+)	Y	Y	Y	Y	N	Y	Y	Y	Y	Y	Y	N	N	N	N	N	N	N	N	N	N	N	N	N	N
1440x900 (WXGA+)	Y	Y	Y	Y	N	Y	Y	Y	Y	Y	Y	Y	N	N	N	N	N	N	N	N	N	N	N	N	N
1600x900 (WXGA++)	Y	Y	Y	Y	N	Y	Y	Y	Y	Y	Y	Y	Y	N	N	N	N	N	N	N	N	N	N	N	N
1600x1200 (UXGA)	Y	Y	Y	Y	N	Y	Y	Y	Y	Y	Y	Y	Y	Y	N	N	N	N	N	N	N	N	N	N	N
1680x1050 (WSXGA+)	Y	Y	Y	Y	N	Y	Y	Y	Y	Y	Y	Y	Y	Y	Y	N	N	N	N	N	N	N	N	N	N
1080i	Y	Y	Y	N	N	N	N	N	N	N	N	N	N	N	N	N	N	N	N	N	N	N	N	N	N
1920x1080 (VESA1080)	Y	Y	Y	N	N	Y	Y	Y	Y	Y	Y	Y	Y	Y	Y	Y	N	N	N	N	N	N	N	N	N
1080p	Y	Y	Y	N	N	Y	Y	Y	Y	Y	Y	Y	Y	Y	Y	Y	N	N	N	N	N	N	N	N	N
1920x1200 (WUXGA)	Y	Y	Y	N	N	Y	Y	Y	N	N	Y	Y	Y	Y	Y	Y	Y	N	N	N	N	N	N	N	N
2048x1152 (QWXGA)	Y	Y	Y	N	N	N	Y	Y	N	N	Y	Y	Y	Y	Y	Y	Y	Y	N	N	N	N	N	N	N
2560x1440 (WQHD)	Y	Y	Y	N	N	N	N	Y	N	N	N	Y	Y	Y	Y	Y	Y	Y	Y	N	N	N	N	N	N
2560x1600 (WQXGA)	Y	Y	Y	N	N	N	N	Y	N	N	Y	Y	Y	Y	Y	Y	Y	Y	Y	Y	N	N	N	N	N
3840x2160@30	Y	Y	Y	N	N	N	N	Y	N	N	Y	Y	Y	Y	Y	Y	Y	Y	Y	Y	Y	Y	N	N	N
3840x2160@60 4:2:0	Y	Y	Y	N	N	N	N	Y	N	N	Y	Y	Y	Y	Y	Y	Y	Y	Y	Y	Y	Y	N	P	N
3840x2160@60 4:4:4	Y	Y	Y	N	N	N	N	Y	N	N	Y	Y	Y	Y	Y	Y	Y	Y	Y	Y	Y	Y	N	Y	N
4096x2160@30	Y	Y	Y	N	N	N	N	Y	N	N	Y	Y	Y	Y	Y	Y	Y	Y	Y	Y	Y	Y	Y	N	N
4096x2160@60 4:2:0	Y	Y	Y	N	N	N	N	Y	N	N	Y	Y	Y	Y	Y	Y	Y	Y	Y	Y	Y	Y	Y	P	P
4096x2160@60 4:4:4	Y	Y	Y	N	N	N	N	Y	N	N	Y	Y	Y	Y	Y	Y	Y	Y	Y	Y	Y	Y	Y	Y	Y

Y: Supported, P: Only YCbCr 4:2:0, N: Not supported

Timing of [720p]/[1080i]/[1080p]/[3840x2160]/[4096x2160] meets the CTA-861 standard.

For other resolutions, timing parameters meet the VESA DMT or VESA CVT standard.

Copying EDID

EDID of sink device is read and saved to the NJR-P.

Item	EDID COPY
For	—
Value	—

Deep Color

You can set the color depth of the NJR-P for if “**EDID selection (P.20)**” is set to [BUILT-IN EDID].

Item	DEEP COLOR
For	HDMI IN
Value	24-BIT COLOR, 30-BIT COLOR, 36 BIT COLOR

If selecting a value other than [24-BIT COLOR] and the source device output video at 30 bit or higher, it may cause noise on the video or signal may not be transmitted. In such a case, the problem may be solved by setting the color to [24-BIT COLOR].

Audio format

You can set the audio format and maximum sampling frequency of the NJR-P for if “**EDID selection (P.20)**” is set to [BUILT-IN EDID].

Item	AUDIO FORMAT
For	HDMI IN
Value	PCM : 32kHz, 44.1kHz, 48kHz, 88.2kHz, 96kHz, 176.4kHz, 192kHz Dolby Digital : OFF, 32kHz, 44.1kHz, 48kHz AAC : OFF, 32kHz, 44.1kHz, 48kHz, 88.2kHz, 96 kHz Dolby Digital+ : OFF, 32kHz, 44.1kHz, 48kHz DTS : OFF, 32kHz, 44.1kHz, 48kHz, 96kHz DTS-HD : OFF, 44.1kHz, 48kHz, 88.2kHz, 96kHz, 176.4kHz, 192kHz Dolby TrueHD: OFF, 44.1kHz, 48kHz, 88.2kHz, 96kHz, 176.4kHz, 192kHz

Note

Some LC monitors do not support some audio formats. Select an supported audio format and sampling frequency.

Speaker configuration

You can set the NJR-P's speaker configuration of multi-channel audio for if "EDID selection (P.20)" is set to [BUILT-IN EDID].

Item	SPEAKER CONFIGURATION	
For	HDMI IN	
	Number of speakers	Number of speakers
Item	1 to 8 (2)	See the table below.
		ON, OFF* *Only FL/FR: ON

Number of speakers	FL/FR	LFE	FC	RL/RR	RC	RLC/RRC
1	OFF	OFF	ON	OFF	OFF	OFF
2	ON	OFF	OFF	OFF	OFF	OFF
3	ON	ON	OFF	OFF	OFF	OFF
4	ON	ON	ON	OFF	OFF	OFF
5	ON	ON	OFF	ON	OFF	OFF
6	ON	ON	ON	ON	OFF	OFF
7	ON	ON	ON	ON	ON	OFF
8	ON	ON	ON	ON	OFF	ON

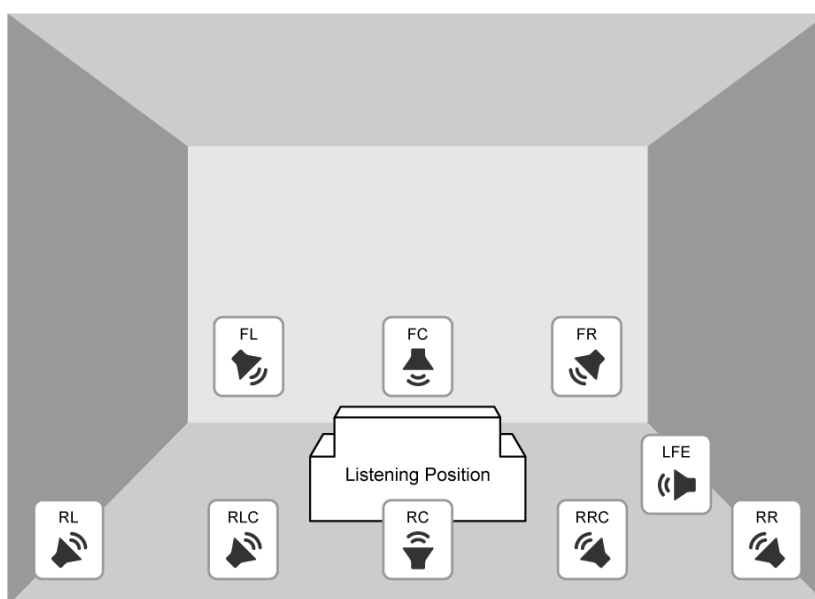

FL	Front Left
FC	Front Center
FR	Front Right
RL	Rear Left
RC	Rear Center

RR	Rear Right
RLC	Rear Left Center
RRC	Rear Right Center
LFE	Low Frequency Effect

RS-232C

The received data from the RS-232C connector can be transmitted to the RS-232C via the cable for extension.

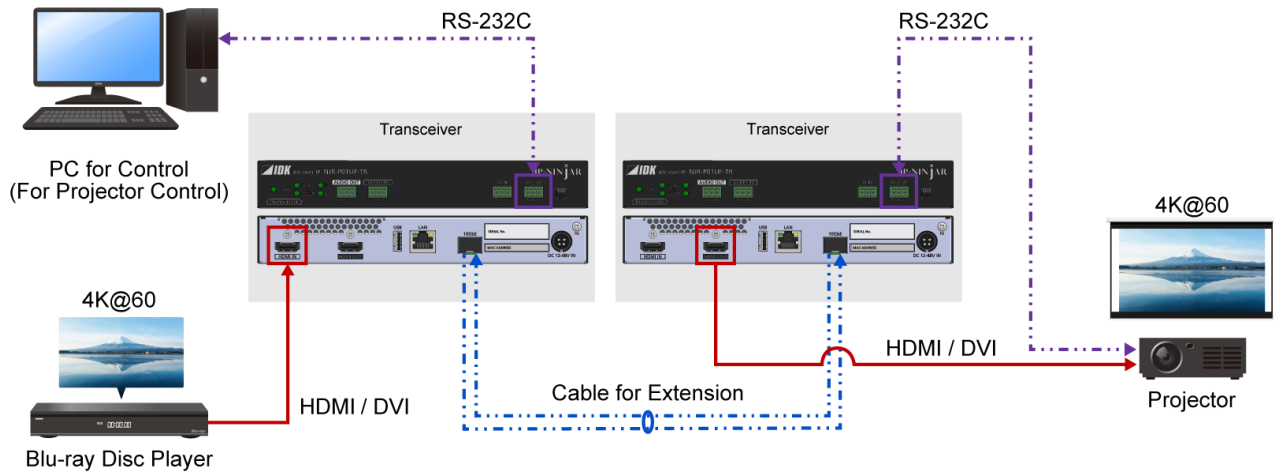

Communication setting

Item	PARAMETERS			
For	Baud rate [bps]	Data bit length [bit]	Parity check	Stop bit [bit]
Value	4800, 9600, 19200, 38400, 57600, 115200	7, 8	NONE, ODD, EVEN	1, 2

LAN

The IP address can be obtained automatically by DHCP (Dynamic Host Configuration Protocol).

Network

Item	IP ADDRESS
Value	0.0.0.0 to 255.255.255.255 (Automatic)

Item	SUBNET MASK
Value	0.0.0.0 to 255.255.255.254 (Automatic)

Item	GATEWAY ADDRESS
Value	0.0.0.0 to 255.255.255.255 (Automatic)

MAC address

Item	MAC address
Value	Specific values of the device

Advanced settings

IR control

You can enable/disable the IR function.

Item	IR RECEIVER
Value	Enabled, Disabled

USB mode

You can select the operation mode based on the device that is connected to the USB connector.

Item	USB
Value	USB LOCAL, USB REMOTE

[USB LOCAL] : For connecting a host, such as a PC.

[USB REMOTE] : For connecting HID devices, such as a keyboard and mouse.

Fan speed

Item	FAN
Value	AUTO, LOW, MIDDLE, HIGH

[AUTO] : Changes the fan speed depending on the internal temperature changes.

[LOW], [MIDDLE], [HIGH] : Keeps the fan speed according to the setting. If the internal temperature exceeds the limit, [AUTO] is applied.

Status

I/O signal status and the NJR-P status can be viewed from the IP-NINJAR Configurator or NJR-CTB.

Factory default list

Setting item		Default
DIP switch	No.1 to 4	OFF
Input	Hot plug output for when there is no active video input signal	10s
	HDCP input	HDCP 2.2 SUPPORT
Output	Signal format	AUTO
	Switching mode	STANDARD
	Output resolution	3840x2160 60Hz
	HDCP authentication	ALWAYS
	Hot plug ignoring duration	OFF
Output audio	Mute	OFF
	Audio mute duration	600ms
	Output audio selection	DIGITAL AUDIO : DIGITAL ANALOG AUDIO : ANALOG
EDID	EDID selection	BUILT-IN EDID
	Resolution	3840x2160@60Hz 4:4:4
	Copying EDID	---
	Deep Color	24-BIT COLOR
	Audio format	PCM: 48kHz, Dolby Digital, AAC, Dolby Digital+, DTS, DTS-HD, Dolby TrueHD: OFF
	Speaker configuration	2
RS-232C	Communication setting	BPS: 9600, LENGTH: 8, PARITY: NONE, STOP: 1
LAN	Network	Automatic
	MAC address	---
Advanced settings	IR control	Enabled
	USB mode	USB LOCAL
	Fan speed	AUTO

Specification

Product specification

		NJR-P01UF-TR
Video/Audio input	HDMI	1 input HDMI/DVI 1.0 TMDS single link, HDCP 1.4/2.2 TMDS clock: Up to 300 MHz, TMDS data rate: Up to 18 Gbps Deep Color/HDR ^{*1} 640x480@60 to 3840x2160@60 Reduced Blanking 480i, 576i to 3840x2160@24/25/30/50/59.94/60 (4:4:4), 3840x2160@50/59.94/60 (4:2:0), 4096x2160@24/25/30/50/59.94/60 (4:4:4), 4096x2160@50/59.94/60 (4:2:0) Color depth: 24/30/36 bits *For all supported video signals, see the table below. LPCM: Up to 8 channels Sampling frequency: 32/44.1/48/88.2/96/176.4/192 kHz Reference level: -20 dBFS, Max. input level: 0 dBFS Connector: HDMI Type A (19-pin) Maximum distances ^{*2} : 98 ft. (30 m) (1080p@60), 39 ft. (12 m) (4K@60)
	Analog audio	1 input Stereo L/R Input impedance: 24 kΩ unbalanced Reference level: -10 dBu, Max. input level: +10 dBu Connector: Captive screw (3-pin)
Video/Audio output	HDMI	1 output HDMI/DVI 1.0 TMDS single link, HDCP 1.4/2.2 TMDS clock: Up to 300 MHz, TMDS data rate: Up to 18 Gbps Deep Color/HDR ^{*1} 640x480@60 to 3840x2160@60 Reduced Blanking 480i, 576i to 3840x2160@24/25/30/50/59.94/60 (4:4:4), 3840x2160@50/59.94/60 (4:2:0), 4096x2160@24/25/30/50/59.94/60 (4:4:4), 4096x2160@50/59.94/60 (4:2:0) Color depth: 24/30/36 bits *For all supported video signals, see the table below. LPCM: Up to 8 channels Sampling frequency: 32/44.1/48/88.2/96/176.4/192 kHz Reference level: -20 dBFS, Max. output level: 0 dBFS Connector: HDMI Type A (19-pin) Maximum distances ^{*2} : 98 ft. (30 m) (1080p@60), 39 ft. (12 m) (4K@60)
	Analog audio	1 output Stereo L/R Output impedance: 50 Ω unbalanced Reference level: -10 dBu, Max. output level: +10 dBu Connector: Captive screw (3-pin)
Video/Audio input/output	10GbE	1 input/output *Input/Output can be carried simultaneously. SDVoE, AES-128 Deep Color/HDR ^{*1} *Supported video signals are the same as those of HDMI. RS-232C/LAN/USB Connector: SFP+ Maximum distances ^{*3} : 984 ft. (300 m) (OM3 Multimode fiber), 6.21 mi. (10 km) (OS1 Singlemode fiber)
Control I/F	RS-232C	1 port/Connector: Captive screw (3-pin)
	LAN	1 port/10Base-T/100Base-TX/1000Base-T (Auto Negotiation), Auto MDI/MDI-X, Connector: RJ-45
	USB	1 port/HID class, Connector: Female Type-A
	IR input	1 port/Connector: Captive screw (3-pin)
Functions		EDID emulation, Connection Reset ^{*4}
General	Power	DC 12 V 1.0 A - DC 48 V 0.27 A ^{*5} AC adapter: AC 100 V - 240 V ±10%, 50 Hz/60 Hz ±3 Hz, DC 12 V 3 A 36.0 W
	Power consumption	14 W
	Dimensions	8.3 (W) × 1.2 (H) × 5.5 (D)" (210 (W) × 30 (H) × 140 (D) mm) (Excluding connectors and the like)
	Weight	2.2 lbs. (1.0 kg)
	Temperature	Operating: 32°F to 104°F (0°C to +40°C), Storage: -4°F to +176°F (-20°C to +80°C)
	Humidity	20% to 90% (Non Condensing)

^{*1} x.v.Color/3D/ARC/HEC/CEC are not supported.

^{*2} The maximum specified distances may not be achievable with some device combinations, cabling method, or other manufacturer's cable. For the same reasons, video signal disturbances or interruptions may occur, even if signals are within the specified distance (cable length) parameters.

The maximum cable length varies depending on the connected devices. The specifications have been qualified under following conditions:

- HDMI (1080p@60) : When IDK's 24 AWG cable was used and signal of 1080p@60 24 bits was transmitted.

- HDMI (4K@60) : When IDK's 18 Gbps supported cable was used and signal of 3840x2160@60 24 bits was transmitted.

^{*3} Only if the SFP+ optical transceiver sold by IDK is used, signals can be transmitted to the mentioned maximum transmission distance. If using other SFP+ optical transceiver, check the compatible fiber and maximum distance of the SFP+ optical transceiver.

^{*4} For digital systems, some problems, such as an HDCP authentication error, can often be recovered by physically disconnecting and reconnecting the digital cables. However, the Connection Reset feature will correct these problems automatically without the need to physically plug and unplug the cables. It creates the same condition as if the cable were physically disconnected and reconnected. This feature only works for the NJR-P's output. Connecting other devices between the NJR-P's outputs and sink devices, may interfere with the operation of this feature.

^{*5} Use Class 2 or LPS.

		NJR-P01UC-TR
Video/Audio input	HDMI	1 input HDMI/DVI 1.0 TMDS single link, HDCP 1.4/2.2 TMDS clock: Up to 300 MHz, TMDS data rate: Up to 18 Gbps Deep Color/HDR ^{*1} 640x480@60 to 3840x2160@60 Reduced Blanking 480i, 576i to 3840x2160@24/25/30/50/59.94/60 (4:4:4), 3840x2160@50/59.94/60 (4:2:0), 4096x2160@24/25/30/50/59.94/60 (4:4:4), 4096x2160@50/59.94/60 (4:2:0) Color depth: 24/30/36 bits *For all supported video signals, see the table below. LPCM: Up to 8 channels Sampling frequency: 32/44.1/48/88.2/96/176.4/192 kHz Reference level: -20 dBFS, Max. input level: 0 dBFS Connector: HDMI Type A (19-pin) Maximum distances ^{*2} : 98 ft. (30 m) (1080p@60), 39 ft. (12 m) (4K@60)
	Analog audio	1 input Stereo L/R Input impedance: 24 kΩ unbalanced Reference level: -10 dBu, Max. input level: +10 dBu Connector: Captive screw (3-pin)
Video/Audio output	HDMI	1 output HDMI/DVI 1.0 TMDS single link, HDCP 1.4/2.2 TMDS clock: Up to 300 MHz, TMDS data rate: Up to 18 Gbps Deep Color/HDR ^{*1} 640x480@60 to 3840x2160@60 Reduced Blanking 480i, 576i to 3840x2160@24/25/30/50/59.94/60 (4:4:4), 3840x2160@50/59.94/60 (4:2:0), 4096x2160@24/25/30/50/59.94/60 (4:4:4), 4096x2160@50/59.94/60 (4:2:0) Color depth: 24/30/36 bits *For all supported video signals, see the table below. LPCM: Up to 8 channels Sampling frequency: 32/44.1/48/88.2/96/176.4/192 kHz Reference level: -20 dBFS, Max. output level: 0 dBFS Connector: HDMI Type A (19-pin) Maximum distances ^{*2} : 98 ft. (30 m) (1080p@60), 39 ft. (12 m) (4K@60)
	Analog audio	1 output Stereo L/R Output impedance: 50 Ω unbalanced Reference level: -10 dBu, Max. output level: +10 dBu Connector: Captive screw (3-pin)
Video/Audio input/output	10GbE	1 input/output *Input/Output can be carried simultaneously. SDVoE, AES-128 Deep Color/HDR ^{*1} *Supported video signals are the same as those of HDMI. RS-232C/LAN/USB Connector: RJ-45 Maximum distance ^{*2} : 328 ft. (100 m) Cable: CAT6A (STP) *For PoE, 24 AWG or thicker cable is recommended.
Control I/F	RS-232C	1 port/Connector: Captive screw (3-pin)
	LAN	1 port/10Base-T/100Base-TX/1000Base-T (Auto Negotiation), Auto MDI/MDI-X, Connector: RJ-45
	USB	1 port/HID class, Connector: Female Type-A
	IR input	1 port/Connector: Captive screw (3-pin)
Functions		EDID emulation, Connection Reset ^{*3}
General	Power	PoE, Connector: RJ-45 (10GbE input) DC 12 V 1.3 A - DC 48 V 0.32 A ^{*4} AC adapter: AC 100 V - 240 V ±10%, 50 Hz/60 Hz ±3 Hz, DC 12 V 3 A 36.0 W
	Power consumption	PoE: 17 W DC 12 V: 17 W
	Dimensions	8.3 (W) × 1.2 (H) × 5.5 (D)" (210 (W) × 30 (H) × 140 (D) mm) (Excluding connectors and the like)
	Weight	2.2 lbs. (1.0 kg)
	Temperature	Operating: 32°F to 104°F (0°C to +40°C), Storage: -4°F to +176°F (-20°C to +80°C)
	Humidity	20% to 90% (Non Condensing)

^{*1} x.v.Color/3D/ARC/HEC/CEC are not supported.

^{*2} The maximum specified distances may not be achievable with some device combinations, cabling method, or other manufacturer's cable. For the same reasons, video signal disturbances or interruptions may occur, even if signals are within the specified distance (cable length) parameters. The maximum cable length varies depending on the connected devices. The specifications have been qualified under following conditions:

- HDMI (1080p@60) : When IDK's 24 AWG cable was used and signal of 1080p@60 24 bits was transmitted.
- HDMI (4K@60) : When IDK's 18 Gbps supported cable was used and signal of 3840x2160@60 24 bits was transmitted.
- 10GbE : When CAT6A (STP) cable is used.

^{*3} For digital systems, some problems, such as an HDCP authentication error, can often be recovered by physically disconnecting and reconnecting the digital cables. However, the Connection Reset feature will correct these problems automatically without the need to physically plug and unplug the cables. It creates the same condition as if the cable were physically disconnected and reconnected. This feature only works for the NJR-P's output. Connecting other devices between the NJR-P's outputs and sink devices, may interfere with the operation of this feature.

^{*4} Use Class 2 or LPS.

Supported video signals

Signal	Resolution	Frame Rate [Hz]	Pixel Clock [MHz]	Color Depth [bits]	INPUT		OUTPUT	
					HDMI 10GbE	HDMI 10GbE	HDMI 10GbE	HDMI 10GbE
640x480@60	640x480	59.94	25.18	24/30/36		○		○
800x600@60	800x600	60.32	40.00	24/30/36		○		○
1024x768@60	1024x768	60.00	65.00	24/30/36		○		○
1280x768@60	1280x768	59.87	79.50	24/30/36		○		○
1280x800@60	1280x800	59.81	83.50	24/30/36		○		○
1280x960@60	1280x960	60.00	108.00	24/30/36		○		○
1280x1024@60	1280x1024	60.02	108.00	24/30/36		○		○
1360x768@60	1360x768	60.02	85.50	24/30/36		○		○
1366x768@60	1366x768	59.79	85.50	24/30/36		○		○
1400x1050@60	1400x1050	59.98	121.75	24/30/36		○		○
1440x900@60	1440x900	59.89	106.50	24/30/36		○		○
1600x900@60	1600x900	59.95	118.25	24/30/36		○		○
1600x1200@60	1600x1200	60.00	162.00	24/30/36		○		○
1680x1050@60	1680x1050	59.95	146.25	24/30/36		○		○
1920x1080@60 RB	1920x1080	59.93	138.50	24/30/36		○		○
1920x1200@60 RB	1920x1200	59.95	154.00	24/30/36		○		○
2048x1152@60 RB	2048x1152	60.00	162.00	24/30/36		○		○
2560x1440@60 RB	2560x1440	59.95	241.50	24/30/36		○		○
2560x1600@60 RB	2560x1600	59.97	268.50	24/30/36		○		○
3840x2160@60 RB	3840x2160	60.00	522.61	24/30/36*		○		○
480i	720x480	59.94	27.00	24/30/36		○		○
480p	720x480	59.94	27.00	24/30/36		○		○
576i	720x576	50.00	27.00	24/30/36		○		○
576p	720x576	50.00	27.00	24/30/36		○		○
720p@50	1280x720	50.00	74.25	24/30/36		○		○
720p@59.94	1280x720	59.94	74.18	24/30/36		○		○
720p@60	1280x720	60.00	74.25	24/30/36		○		○
1080i@50	1920x1080	25.00	74.25	24/30/36		○		○
1080i@59.94	1920x1080	29.97	74.18	24/30/36		○		○
1080i@60	1920x1080	30.00	74.25	24/30/36		○		○
1080p@50	1920x1080	50.00	148.50	24/30/36		○		○
1080p@59.94	1920x1080	59.94	148.35	24/30/36		○		○
1080p@60	1920x1080	60.00	148.50	24/30/36		○		○
3840x2160@23.98	3840x2160	23.98	296.70	24/30/36		○		○
3840x2160@24	3840x2160	24.00	297.00	24/30/36		○		○
3840x2160@25	3840x2160	25.00	297.00	24/30/36		○		○
3840x2160@29.97	3840x2160	29.97	296.70	24/30/36		○		○
3840x2160@30	3840x2160	30.00	297.00	24/30/36		○		○
3840x2160@50	3840x2160	50.00	594.00	24/30/36*		○		○
3840x2160@59.94	3840x2160	59.94	593.41	24/30/36*		○		○
3840x2160@60	3840x2160	60.00	594.00	24/30/36*		○		○
4096x2160@23.98	4096x2160	23.98	296.70	24/30/36		○		○
4096x2160@24	4096x2160	24.00	297.00	24/30/36		○		○
4096x2160@25	4096x2160	25.00	297.00	24/30/36		○		○
4096x2160@29.97	4096x2160	29.97	296.70	24/30/36		○		○
4096x2160@30	4096x2160	30.00	297.00	24/30/36		○		○
4096x2160@50	4096x2160	50.00	594.00	24/30/36*		○		○
4096x2160@59.94	4096x2160	59.94	593.41	24/30/36*		○		○
4096x2160@60	4096x2160	60.00	594.00	24/30/36*		○		○

RB: Reduced Blanking

*For RGB/YCbCr 4:4:4, only 24 bit is supported.

For best results, please confirm that the source device(s) video output can be configured to match the listed formats above. For questions regarding other input video signals, please contact your IDK representative.

Troubleshooting

This chapter provides recommendations in case difficulties are encountered during NJR-P setup and operation.

In case the NJR-P does not work correctly, please check the following items first.

- Are the NJR-P and all devices connected to power and powered on?
- Are signal cables connected correctly?
- Are there any loose or partially mated connections?
- Are the interconnecting cables specified correctly to support adequate bandwidth?
- Are specifications of connected devices matched to each other?
- Are configuration settings for the connected devices correct?
- Is there any nearby equipment that may cause electrical noise/RF interference?

Refer to the manuals of connected devices as well, since they may possibly be the cause of the problem.

If the problem persists, please contact us after checking the following items.

- Does the problem occur at all connectors?
- Does the problem occur when you connect the devices without connecting the NJR-P?

HDMI Transceiver

NJR-P01Ux-TR Series

User Guide



www.idkav.com

Headquarters

IDK Corporation

7-9-1 Chuo, Yamato, Kanagawa, 242-0021, JAPAN

TEL: +81-46-200-0764 FAX: +81-46-200-0765

Email: idk_eng@idk.co.jp

USA

IDK America Inc.

72 Grays Bridge Road Suite 1-C, Brookfield,
CT 06804, United States

TEL: +1-203-204-2445

Email: sales@idkav.com

Europe

IDK Europe GmbH

Lise-Meitner-Str. 6, D-40878 Ratingen, Germany

TEL: +49-2102-578-301-0

Email: info@idkav.eu

Vietnam

IDK Corporation Vietnam

Hanoi Representative Office

TEL: +84-247-108-8866

Email: info_en@idk.co.jp

IDK Corporation Vietnam

Ho Chi Minh Representative Office

TEL: +84-28-7108-8954

Email: info_en@idk.co.jp