

## Power Distribution Unit

# PD-S15

<User Guide>

Ver.1.2.0

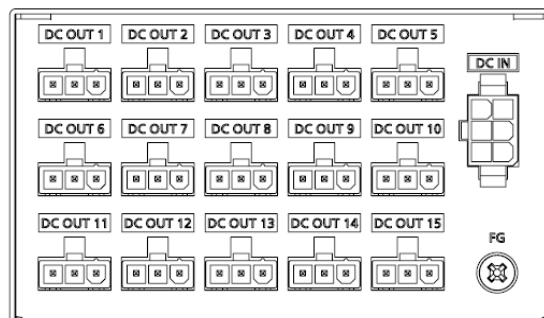
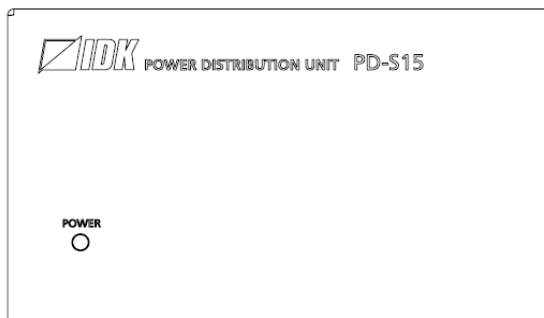

- Thank you for choosing our product.
- To ensure the best performance of this product, please read this user guide fully and carefully before using it and keep this manual together with the product for future reference as needed.

## **Trademarks**

- HDBaseT™ and the HDBaseT Alliance Logo are trademarks of the HDBaseT Alliance.
- The terms HDMI and HDMI High-Definition Multimedia Interface, and the HDMI Logo are trademarks or registered trademarks of HDMI Licensing Administrator, Inc. in the United States and other countries.
- SDVoE™ and SDVoE logo are trademarks of SDVoE Alliance.
- All other company and product names mentioned in this document are either registered trademarks or trademarks of their respective owners. In this document, the “®” or “™” marks may not be specified.
- ©2021 IDK Corporation, all rights reserved.

# Before reading this manual

- All rights reserved.
- Some information contained in this user guide such as exact product appearance, diagrams, and so on may differ depending on the product version.
- This user guide is subject to change without notice. You can download the latest version from IDK's website at: [www.idkav.com](http://www.idkav.com)

**FCC STATEMENT**

**Note:** This equipment has been tested and found to comply with the limits for a Class A digital device, pursuant to part 15 of the FCC Rules. These limits are designed to provide reasonable protection against harmful interference when the equipment is operated in a commercial environment. This equipment generates, uses, and can radiate radio frequency energy and, if not installed and used in accordance with the instruction manual, may cause harmful interference to radio communications. Operation of this equipment in a residential area is likely to cause harmful interference, in which case the user will be required to correct the interference at his own expense.

(Class A)

**Supplier's Declaration of Conformity  
47 CFR § 2.1077 Compliance Information**

**Unique Identifier**

Type of Equipment: POWER DISTRIBUTION UNIT

Model Name: PD-S15

**Responsible Party – U.S. Contact Information**

Company Name: IDK America Inc.

Address: 72 Grays Bridge Road Suite 1-C, Brookfield, CT 06804

Telephone number: +1-203-204-2445

URL: www.idkav.com

**FCC Compliance Statement**

This device complies with Part 15 of the FCC Rules. Operation is subject to the following two conditions: (1) This device may not cause harmful interference, and (2) this device must accept any interference received, including interference that may cause undesired operation.

(FCC SDoC)

**CE MARKING**

This equipment complies with the essential requirements of the relevant European health, safety and environmental protection legislation.

**WEEE MARKING**





Waste Electrical and Electronic Equipment (WEEE), Directive 2002/96/EC  
(This directive is only valid in the EU.)







This equipment complies with the WEEE Directive (2002/96/EC) marking requirement.  
The left marking indicates that you must not discard this electrical/electronic equipment in domestic household waste.

# Safety Instructions

Read all safety and operating instructions before using this product. Follow instructions and heed warnings/cautions.

Instructions and warnings/cautions for all products are provided. Some of them may not be applicable to your product.

	<h2>Warning</h2>	Indicates the presence of a hazard that may result in death or serious personal injury if the warning is ignored or the product is handled incorrectly.
	<h2>Caution</h2>	Indicates the presence of a hazard that may cause minor personal injury or property damage if the caution is ignored or the product is handled incorrectly.

Symbol	Description	Example
 Caution	This symbol is intended to alert the user. (Warning and caution)	 Hot surfaces Caution
 Prohibited	This symbol is intended to prohibit the user from specified actions.	 Do not disassemble
 Instruction	This symbol is intended to instruct the user.	 Unplug

## Warning

### For lifting heavy products:

 Instruction	<ul style="list-style-type: none"> <li>● <b>Lifting must be done by two or more personnel.</b></li> </ul> <p>To avoid injury: When lifting the product, bend your knees, keep your back straight and get close to it with two or more persons.</p>
--	--





### For installing and connecting products:

 Prohibited	<ul style="list-style-type: none"> <li>● <b>Do not place the product in unstable place.</b></li> </ul> <p>Install the product in a horizontal and stable place, as this may fall or tip over and cause injury.</p> <ul style="list-style-type: none"> <li>● <b>Secure the product if installing in the locations with vibration.</b></li> </ul> <p>Vibration may move or tip over the product unexpectedly, resulting in injury.</p>
---	--

# Warning

 <b>Instruction</b>	<ul style="list-style-type: none"> <li>● <b>Installation work must be performed by professionals.</b> The product is intended to be installed by skilled technicians. For installation, please contact a system integrator or IDK. Improper installation may lead to the risk of fire, electric shock, injury, or property damage.</li> <li>● <b>Insert the power plug into an outlet that is unobstructed.</b> Unobstructed access to the plug enables unplugging the product in case of any extraordinary failure, abnormal situation or for easy disconnection during extended periods of non-use.</li> <li>● <b>Insert the power plug into an appropriate outlet completely.</b> If the plug is partially inserted, arcing may cause the connection to overheat, increasing the risk of electric shock or fire. Do not use a damaged plug or connect to a loose outlet.</li> <li>● <b>Unplug the product from an AC power source during installation or service.</b> When connecting peripheral devices to this product, unplug all involved devices from outlets. Ground potential differences may cause fire or other difficulties.</li> <li>● <b>The product must be electrically earthed/grounded.</b> To reduce the risk of electric shock, ensure the product is connected to a mains socket outlet with a protective earthing connection.</li> <li>● <b>For PoE/PoH, use category cables meeting IEEE802.3af/at.</b> Otherwise, it may cause problems or a fire.</li> </ul>
---	--

**For operating products:**



 <b>Prohibited</b>	<ul style="list-style-type: none"> <li>● <b>Keep out any foreign objects.</b> To avoid fire or electric shock, do not permit foreign objects, such as metal and paper, to enter the product from vent holes or other apertures.</li> <li>● <b>For power cable/plug and Category cable,</b> <ul style="list-style-type: none"> <li>• Do not scratch, heat, or modify, including splicing or lengthening them.</li> <li>• Do not pull, place heavy objects on them, or pinch them.</li> <li>• Do not bend, twist, tie or clamp them together forcefully.</li> </ul> </li> </ul> <p>Misuse of the power cable and plug may cause fire or electric shock. If power cables/plugs become damaged, contact your IDK representative.</p>
 <b>Do not disassemble</b>	<ul style="list-style-type: none"> <li>● <b>Do not repair, modify or disassemble.</b> Since the product includes circuitry that uses potentially lethal, high voltage levels, disassembly by unauthorized personnel may lead to the risk of fire or electric shock. For internal inspection or repair, contact your IDK representative.</li> </ul>
 <b>Do not touch</b>	<ul style="list-style-type: none"> <li>● <b>Do not touch the product and connected cables during electric storms.</b> Contact may cause electric shock.</li> </ul>
 <b>Instruction</b>	<ul style="list-style-type: none"> <li>● <b>Clean the power plug regularly.</b> If the plug is covered in dust, it may increase the risk of fire.</li> </ul>

**If the following problem occurs:**





 <b>Unplug</b>	<ul style="list-style-type: none"> <li>● <b>Unplug immediately if the product smokes, makes unusual noise, or produces a burning odor.</b></li> <li>● <b>Unplug immediately if the product is damaged by falling or having been dropped.</b></li> <li>● <b>Unplug immediately if water or other objects are directed inside.</b></li> </ul> <p>If you continue to use the product under these conditions, it may increase the risk of electric shock or fire. For maintenance and repair, contact your IDK representative.</p>
--	--

# **Caution**

**For installing and connecting products:**

 <b>Prohibited</b>	<ul style="list-style-type: none"> <li>● <b>Do not place the product in a location where it will be subjected to high temperatures.</b> If the product is subjected to direct sunlight or high temperatures while under operation, it may affect the product's performance and reliability and may increase the risk of fire.</li> <li>● <b>Do not store or operate the product in dusty, oil smoke filled, or humid place.</b> Placing the product in such environment may increase the risk of fire or electric shock.</li> <li>● <b>Do not block the vent holes.</b> If ventilation slots are blocked, it may cause the product to overheat, affecting performance and reliability and may increase the risk of fire.</li> <li>● <b>Do not place or stack heavy items on the product.</b> Failure to observe this precaution may result in damage to the product itself as well as other property and may lead to the risk of personal injury.</li> <li>● <b>Do not exceed ratings of outlet and wiring devices.</b> Exceeding the rating of an outlet may increase the risk of fire and electric shock.</li> </ul>
 <b>No wet hands</b>	<ul style="list-style-type: none"> <li>● <b>Do not handle power plug with wet hands.</b> Failure to observe this precaution may increase the risk of electric shock.</li> </ul>
 <b>Instruction</b>	<ul style="list-style-type: none"> <li>● <b>Use and store the product within the specified temperature/humidity range.</b> If the product is used outside the specified range of temperature and humidity continuously, it may increase the risk of fire or electric shock.</li> <li>● <b>Do not place the product at elevations of 1.24 mi. (2,000 m) or higher above sea level.</b> Failure to do so may shorten the life of the internal parts and result in malfunctions.</li> <li>● <b>When mounting the product into the rack, provide sufficient cooling space.</b> Mount the product in a rack meeting EIA standards, and maintain spaces above and below for air circulation. For your safety as required, attach an L-shaped bracket in addition to the panel mount bracket kit to improve mechanical stability.</li> <li>● <b>Never insert screws without the rubber feet into the threaded holes on the bottom of the product.</b> Never insert screws alone into the threaded holes on the bottom of the product. Doing so may lead to damage when the screws contact electric circuitry or components inside the product. Reinstall the originally supplied rubber feet using the originally supplied screws only.</li> </ul>

**For operating products:**

 <p><b>Hot surfaces Caution</b></p>	<p><b>For products with the hot surfaces caution label only:</b></p> <ul style="list-style-type: none"> <li>• <b>Do not touch the product’s hot surface.</b></li> </ul> <p>If the product is installed without enough space, it may cause malfunction of other products. If you touch product’s hot surface, it may cause burns.</p>
 <p><b>Prohibited</b></p>	<ul style="list-style-type: none"> <li>• <b>Use only the supplied power cable and AC adapter.</b></li> <li>• <b>Do not use the supplied power cable and AC adapter with other products.</b></li> </ul> <p>If non-compliant adapter or power cables are used, it may increase the risk of fire or electric shock.</p>
 <p><b>Unplug</b></p>	<ul style="list-style-type: none"> <li>• <b>If the product won’t be used for an extended period of time, unplug it.</b></li> </ul> <p>Failure to observe this precaution may increase the risk of fire.</p> <ul style="list-style-type: none"> <li>• <b>Unplug the product before cleaning.</b></li> </ul> <p>To prevent electric shock.</p>
 <p><b>Instruction</b></p>	<ul style="list-style-type: none"> <li>• <b>Do not prevent heat release.</b></li> </ul> <p>If cooling fan stops, power off the product and contact IDK. Failure to do so may raise internal temperature and increase the risk of malfunction, fire, or electric shock.</p> <ul style="list-style-type: none"> <li>• <b>Keep vents clear of dust.</b></li> </ul> <p>If the vent holes near the cooling fan or near the fan are covered with dust, internal temperatures increase and may increase the risk of malfunction. Clean the vent holes and near the fan as needed. If dust accumulates inside of the product, it may increase the risk of fire or electric shock. Periodic internal cleaning, especially before humid rainy season, is recommended. For internal cleaning, contact your IDK representative.</p>



## Table of Contents

1	Included Items .....	10
2	About PD-S15 .....	11
3	Features .....	11
4	Panels .....	12
5	System Configuration Example .....	13
6	Precautions .....	14
6.2	Installation .....	14
6.3	Mounting to RM series .....	14
7	Connecting to compatible models .....	16
7.1	Precautions .....	16
7.2	Connecting devices .....	16
7.3	Connecting power cord .....	17
7.4	Overcurrent protection .....	17
8	Product specification .....	18

# 1 Included Items

---

Ensure that all items below are included in the package.  
If any items are missing or damaged, please contact IDK.

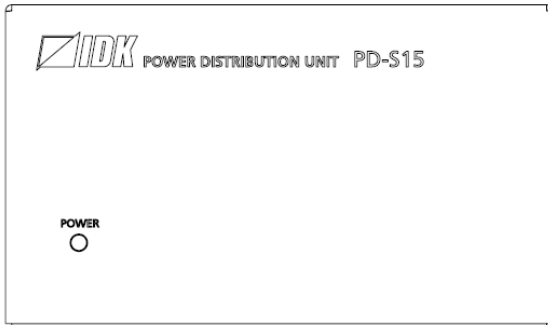

One (1) PD-S15

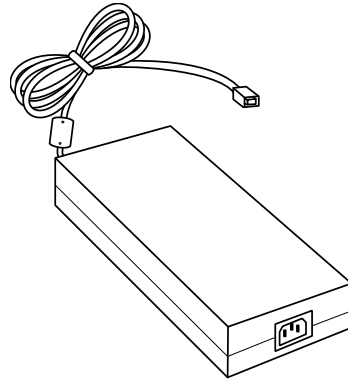

One (1) AC power adapter

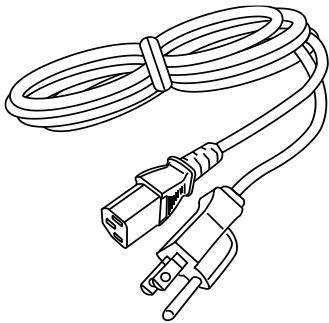

One (1) power cord, 6 ft. (1.8 m)

**[Fig. 1.1] Included items**

## 2 About PD-S15

The PD-S15 is a power distribution unit with 5 V and 12 VDC power.

By using a dedicated DC power cable (sold separately), the PD-S15 supplies power to up to 15 IDK products which operate via an AC adapter.

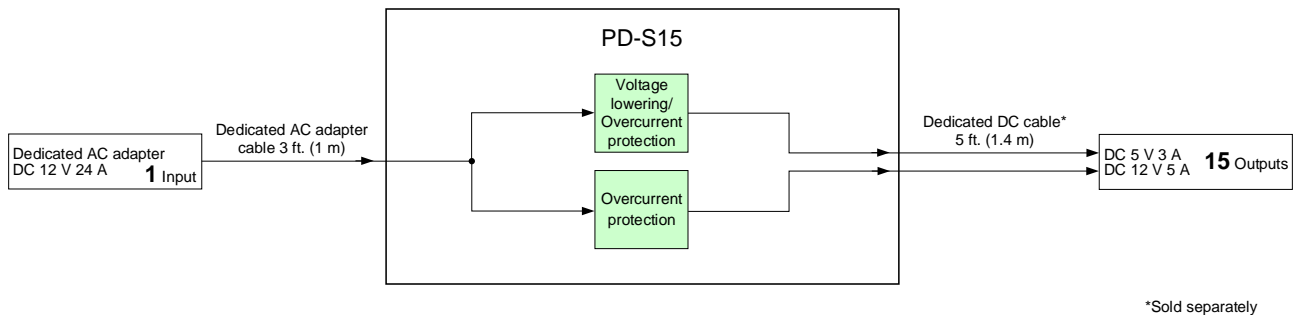

[Fig. 2.1] Diagram

## 3 Features

- Multi voltage distribution (5 V/12 V)
- Providing power up to 15 IDK devices
- Overcurrent protection
- Can be mounted to IDK RM-SV series

## 4 Panels

### ● Front panel

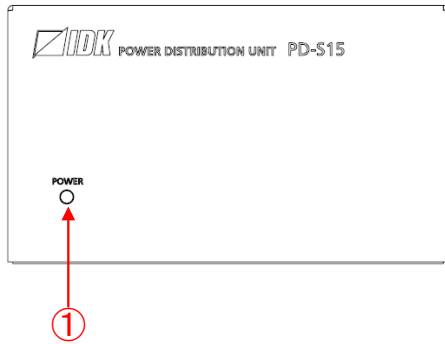

### ● Rear panel

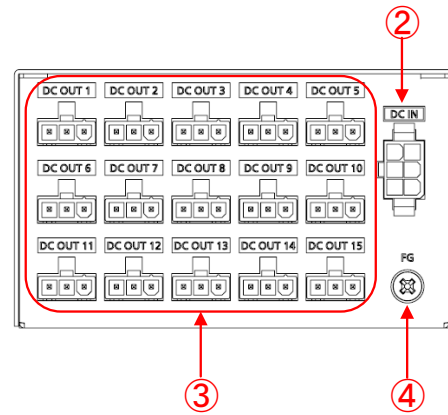

[Fig. 4.1] Drawing

[Table 4.1] Features

①	LED for power status	Illuminates in green when power is supplied from the DC input connector.
②	DC input connector	For use with supplied AC adapter
③	DC output connectors	Supply powers, DC 5 V or 12 V, up to 15 outputs over a dedicated DC cable. Current of each output is controlled separately.
④	Frame ground	Use for bonding chassis to local ground. An M4 screw is used.

# 5 System Configuration Example

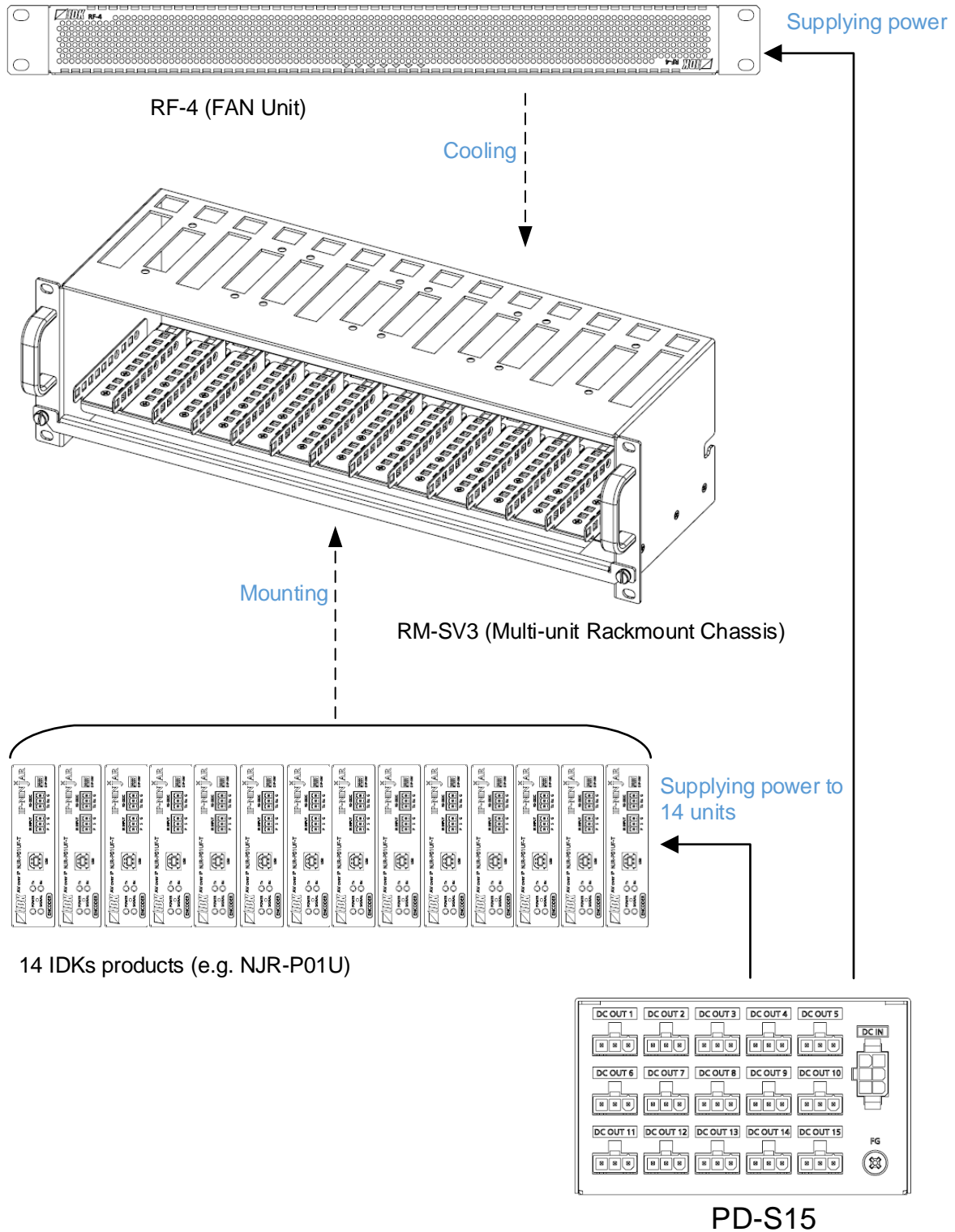

[Fig. 5.1] System configuration example

## 6 Precautions

---

### 6.2 Installation

---

When installing the PD-S15, please observe the following precautions; otherwise, the internal temperature increases and it may affect the product lifetime and operation.

- Do not stack or place one PD-S15 directly on top of another PD-S15.
- Do not block vent holes.
- To provide adequate ventilation, maintain sufficient clearances around the PD-S15 (1.2 in. (30 mm) or more), except for when mounted to a rack.
- Consider installing the PD-S15 in an environment compatible with the maximum temperature indicated in the specification sheet 32°F to 104°F (0°C to +40°C).

### 6.3 Mounting to RM series

---

The PD-S15 can be mounted to RM series. Refer to the user manual of the RM series for details.

● Mounting to RM-SV3

Remove the partition bracket of slot No.14.

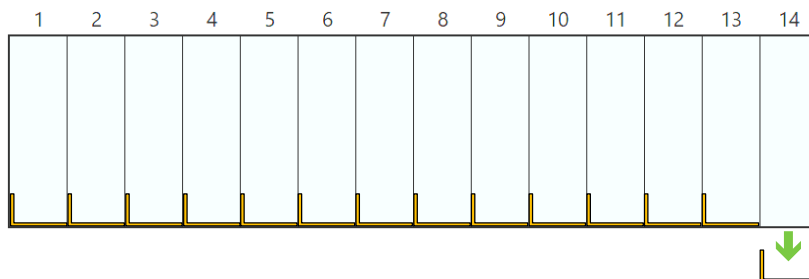

Attach the partition bracket to the PD-S15 to space of slots No.13 and 14.

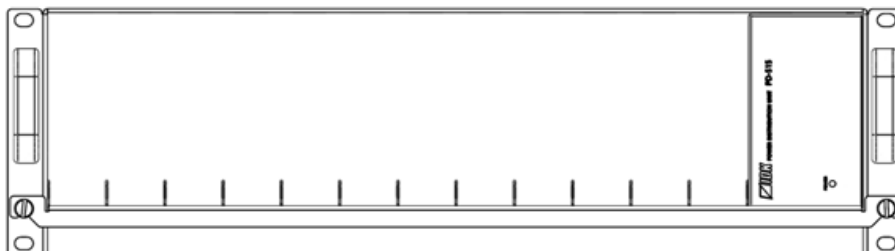

[Fig. 6.1] Mounting to RM-SV3

● Mounting to RM-SV5

Remove the partition brackets of slot No.13 and 14, and then attach the RM-QSP to space of slot No.13.

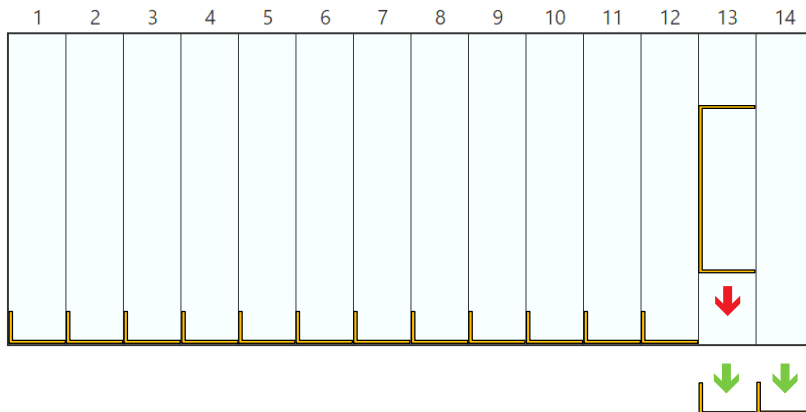

Attach the partition bracket to the PD-S15 to space of slots No.13 and 14.

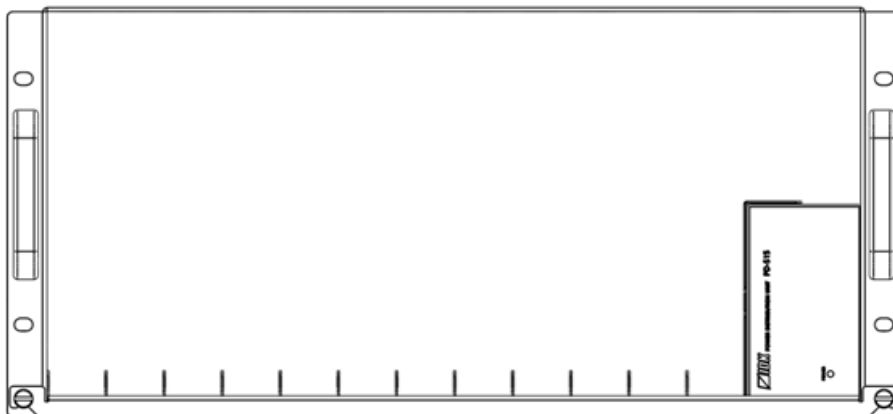

[Fig. 6.2] Mounting RM-SV5

● Mounting to RM-SF

Secure the PD-S from the bottom of the RM-SF using screws.



2U height is necessary.

[Fig. 6.3] Mounting to RM-SF

## 7 Connecting to compatible models

### 7.1 Precautions

When connecting the PD-S15 to IDK products which operate via an AC adapter, observe the following precautions.

- Read manuals of the IDK products.
- Before connecting cables to the PD-S15 or IDK products, dissipate static electricity by touching grounded metal such as equipment racks before handling signal cables. Failure to observe this precaution may result in ESD (electrostatic discharge) damage.
- Power all units off before connecting cables.
- Be sure to fully seat all plugs and connections and dress cables to reduce stress on connectors.
- Do not connect incompatible products to the PD-S15.
- Do not connect cables other than the dedicated DC power cable (sold separately).

### 7.2 Connecting devices

Since the DC output connectors support both DC 5 V and 12 V, prepared the needed DC power cables which are sold separately.

To connect the DC 12 V power cable to the PD-S15, insert the cable connector securely until it clicks. To remove the DC power cable, loosen the connector and pull the cable.

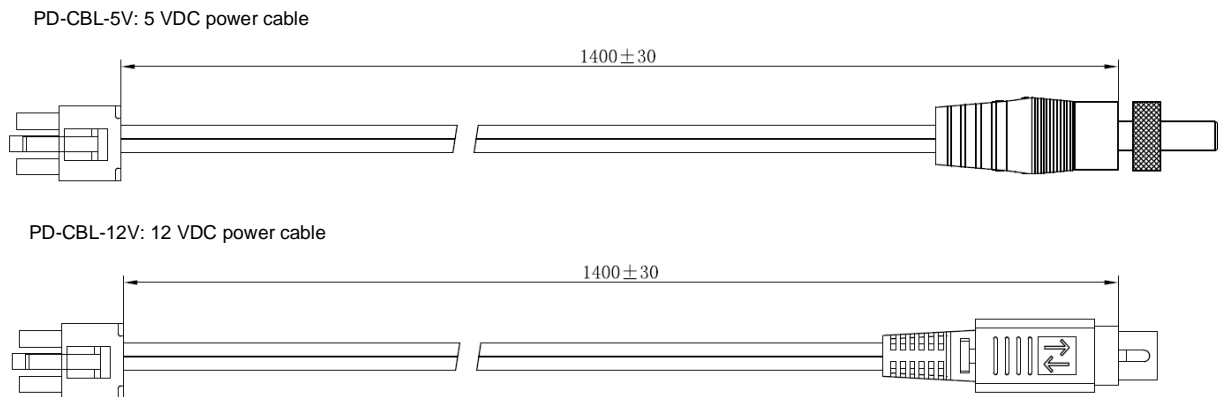

[Fig. 7.1] DC power cable



## 7.3 Connecting power cord

---

Connect the supplied power cord to the AC power adapter.

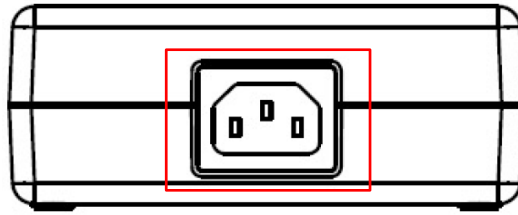

[Fig. 7.2] Power cord connector

## 7.4 Overcurrent protection

---

If a DC output connector detects overcurrent (exceeding DC 5 V 3 A), the connector stops supplying power temporarily. Once the overcurrent is recovered, the connector automatically restarts to supply power. In case if current exceeds DC 12 V 5 A, the internal fuse is blown and stop supplying power from the DC output connector, and it needs to be repaired. Please contact us.

In addition to overcurrent protection, the AC power adapter features protections from short circuit, over voltage, and overheat. If a problem is detected and the protection function is activated, the AC adapter stops supplying power. To activate the adapter, unplug it and wait for 10 seconds, and then plug it again. When the problem is solved, the AC adapter restarts to supply power.

## 8 Product specification

Item		Description
DC power output		15 outputs 5 VDC, 3 A or 12 VDC, 5 A (Maximum distribution power: 260 W)
Function		Overcurrent protection
General	Dimensions (Unit)	4.2 (W) x 2.4 (H) x 5.9 (D)" (106 (W) x 61 (H) x 150 (D) mm) (Excluding connectors and the like)
	Weight (Unit)	1.8 lbs. (0.8 kg)
	AC adapter	Input : 100 - 240 VAC ±10%, 50 Hz/60 Hz ±3 Hz Output : DC 12 V 24 A 288.0 W (A dedicated AC adapter is provided)
	Dimensions (AC adapter)	4.6 (W) x 1.9 (H) x 10 (D)" (116 (W) x 47 (H) x 254 (D) mm) (Excluding connectors and the like)
	Weight (AC adapter)	3.5 lbs. (1.6 kg)
	Power consumption	About 6.5 W
	Temperature	Operating : 32°F to 104°F (0°C to +40°C) Storage : -4°F to +176°F (-20°C to +80°C)
	Humidity	Operating/Storage: 20% to 90% (Non Condensing)

---

## User Guide of PD-S15

Ver.1.2.0

Issued on: 8 August 2023

---



### Headquarters

IDK Corporation  
7-9-1 Chuo, Yamato-shi, Kanagawa-pref.  
242-0021 JAPAN  
TEL: +81-46-200-0764 FAX: +81-46-200-0765

Email: [idk\\_eng@idk.co.jp](mailto:idk_eng@idk.co.jp)

URL: [www.idkav.com](http://www.idkav.com)

### USA

IDK America Inc.  
72 Grays Bridge Road Suite 1-C, Brookfield, CT 06804  
TEL: +1-203-204-2445

Email: [sales@idkav.com](mailto:sales@idkav.com)

URL: [www.idkav.com](http://www.idkav.com)

### Europe

IDK Europe GmbH  
Lise-Meitner-Str. 6, D-40878 Ratingen  
TEL: +49-2102-578-301-0

Email: [info@idkav.eu](mailto:info@idkav.eu)

URL: [www.idkav.com](http://www.idkav.com)



### Product information Support

Arvanics Corporation  
7-9-1 Chuo, Yamato-shi, Kanagawa-pref.  
242-0021 JAPAN  
TEL: +81-46-259-6920 FAX: +81-46-259-6930

Email: [info@arvanics.com](mailto:info@arvanics.com)

URL: [www.arvanics.com](http://www.arvanics.com)

Information in this document is subject to change without notice.

©2021 IDK Corporation, all rights reserved. All trademarks mentioned are the property of their respective owners.