

UNITS mm [in]		MODEL MSD-V41UC	
DRAWN Shibata 2022/08/30	CHECKED Watanabe 2022/08/30	APPROVED Kadowaki 2022/08/30	PART NAME Product Dimensions DWG No. 515E14
IDK Corporation www.idk.co.jp			REVISION C1
SCALE : 1:2 (A3)			PAGE 1 / 2

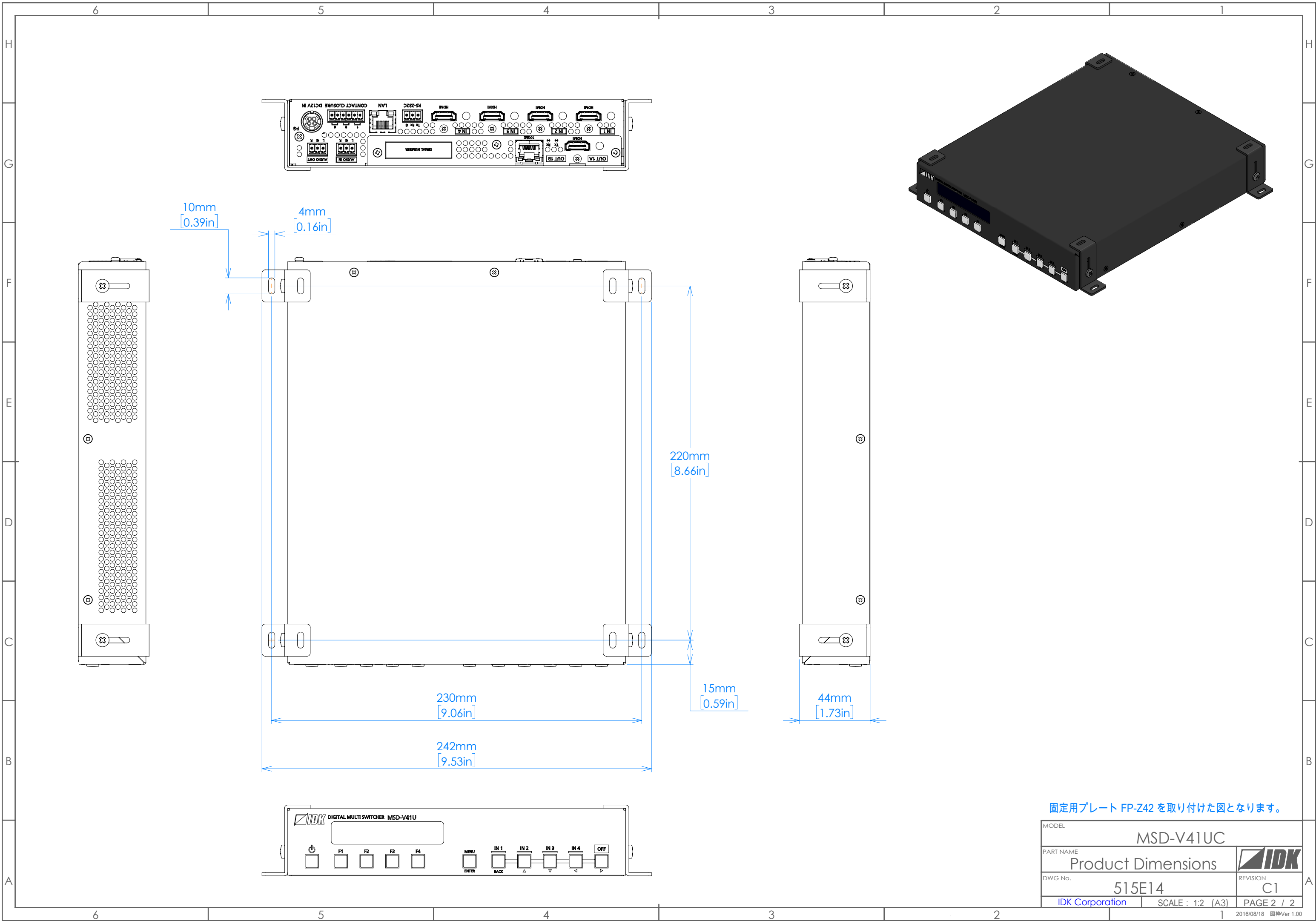

固定用プレート FP-Z42 を取り付けた図となります。

MODEL	MSD-V41UC	
PART NAME	Product Dimensions	
DWG No.	515E14	REVISION C1
IDK Corporation	SCALE : 1:2 (A3)	PAGE 2 / 2