

UNITS mm [ in ]		MODEL VAC-S18U	
DRAWN Shibata 2022/05/09	CHECKED Watanabe 2022/05/09	APPROVED Kadowaki 2022/05/09	PART NAME 外観図 DWG No. 114E81
IDK Corporation www.idk.co.jp			REVISION B1
SCALE : 1:2 (A3)			PAGE 1 / 2

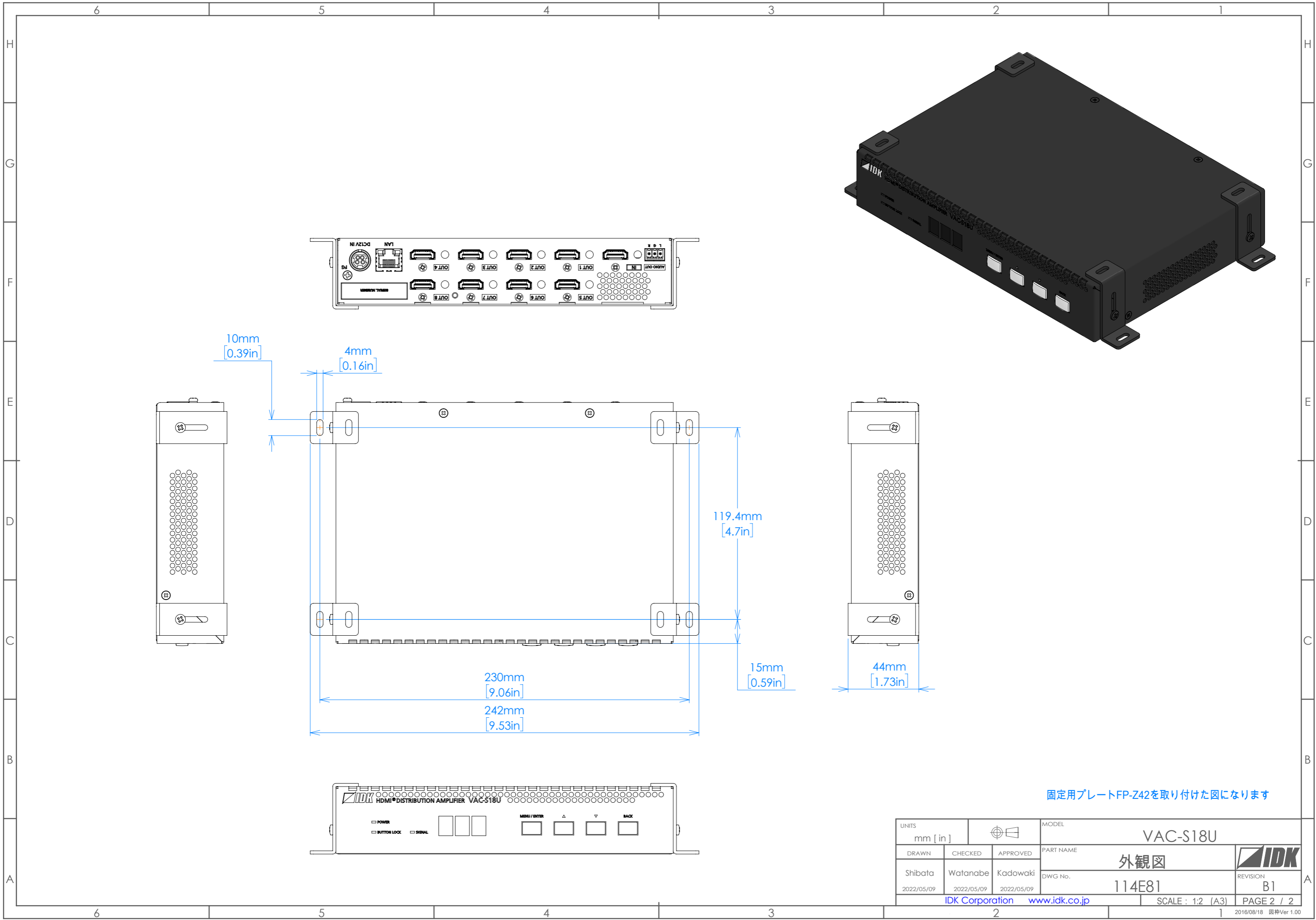

固定用プレートFP-Z42を取り付けた図になります

UNITS mm [ in ]		MODEL VAC-S18U	
DRAWN Shibata 2022/05/09	CHECKED Watanabe 2022/05/09	APPROVED Kadowaki 2022/05/09	PART NAME 外観図 DWG No. 114E81
IDK Corporation <a href="http://www.idk.co.jp">www.idk.co.jp</a>			REVISION B1
SCALE : 1:2 (A3)			PAGE 2 / 2